



Martin V-BELT PULLEYS

WWW.MARTINSPROCKET.COM



V-Belt Pulley Nomenclature

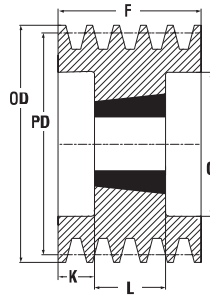

SOLID TYPE 3 CONSTRUCTION

of Grooves **4 SPB 150 2517**

Belt Section
SPA, SPB, SPC, SPZ

Pitch Diameter

Taper Bushed

SPOKED TYPE 5 CONSTRUCTION

4 SPB 425 3525 Taper Bushed

Pitch Diameter

Belt Section
SPA, SPB, SPC, SPZ

of Grooves

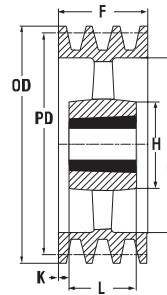

SOLID TYPE 6 CONSTRUCTION

of Grooves **3 SPB 100 1610**

Belt Section
SPA, SPB, SPC, SPZ

Pitch Diameter

Taper Bushed

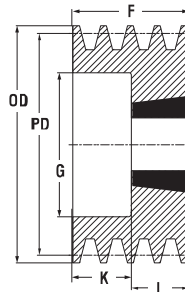

SOLID TYPE 2 CONSTRUCTION

3 SPB 140 2012 Taper Bushed

Pitch Diameter

Belt Section
SPA, SPB, SPC, SPZ

of Grooves

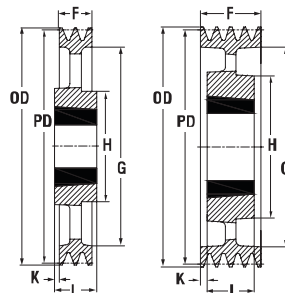
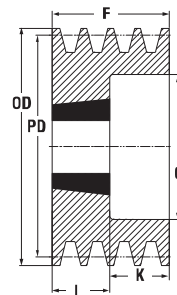

SPOKED TYPE 10 & 11 CONSTRUCTION

of Grooves **2 SPB 280 2517**

Belt Section
SPA, SPB, SPC, SPZ

Pitch Diameter

Taper Bushed

MTO V-Belt Pulley Capabilities

- Ductile Iron, Steel, Cast Iron
- Finished Bore
- Fractional Horsepower
- Idler Wheels
- Flat Pulleys
- Fly Wheels
- Wire Rope
- Crusher Duty

General Balancing Guidelines

- **6,500 FPM & Less:**
Cast Iron, Static Balance (*Martin* Stock V-Belt Pulleys).
- **6,501 FPM and Over:**
Ductile Iron or Steel, Dynamic Balance.
- Contact *Martin* for specific application assistance.



V-BELT DRIVES

PRODUCT	PAGE
INDEX	D-1
TAPER BUSHED PULLEYS SPZ	
SPZ 1 - 2 GROOVES.....	D-3
SPZ 3 - 4 GROOVES.....	D-4
SPZ 5 - 6 GROOVES.....	D-5
SPZ 8 GROOVES.....	D-6
TAPER BUSHED PULLEYS SPA	
SPA 1 - 2 GROOVES	D-7
SPA 3 - 4 GROOVES	D-8
SPA 5 - 6 GROOVES	D-9
TAPER BUSHED PULLEYS SPB	
SPB 1 - 2 GROOVES.....	D-10
SPB 3 - 4 GROOVES.....	D-11
SPB 5 - 6 GROOVES.....	D-12
SPB 8 - 10 GROOVES.....	D-13
TAPER BUSHED PULLEYS SPC	
SPC 3 - 4 GROOVES.....	D-14
SPC 5 - 6 GROOVES.....	D-15
SPC 8 - 10 GROOVES.....	D-16

Warning & Safety Reminder

The Martin logo is displayed in a white, cursive font on a dark blue rectangular background.

WARNING & SAFETY REMINDER

Safety must be considered a basic factor in machinery operation at all times. Most accidents are the result of carelessness or negligence. All rotating power transmission products are potentially dangerous and must be guarded by the contractor, installer, purchaser, owner, and user as required by applicable laws, regulations, standards, and good safety practice. Additional specific information must be obtained from other sources including the latest editions of American Society of Mechanical Engineers; Standard A.N.S.I. B15.1. A copy of this standard may be obtained from the American Society of Mechanical Engineers at 345 East 47th Street, New York, NY 10017 (212-705-7722).

It is the responsibility of the contractor, installer, purchaser, owner, and user to install, maintain, and operate the parts or components manufactured and supplied by *Martin* Sprocket & Gear, Inc., in such a manner as to comply with the Williams-Steiger Occupational Safety Act and with all state and local laws, ordinances, regulations, and the American National Standard Institute Safety Code.

CAUTION

Guards, access doors, and covers must be securely fastened before operating any equipment.

If parts are to be inspected, cleaned, observed, or general maintenance performed, the motor driving the part or components is to be locked out electrically in such a manner that it cannot be started by anyone, however remote from the area. Failure to follow these instructions may result in personal injury or property damage.

WARNING

NOTE: CATALOG DIMENSIONS

Every effort is made to keep all catalog dimensions and styles current in the catalog, however from time to time, it is necessary because of manufacturing changes to alter stock products dimensionally.

If any stock product dimension or style shown in this catalog is critical to your application please consult factory for certification.



Taper Bushed Pulley **SPZ**

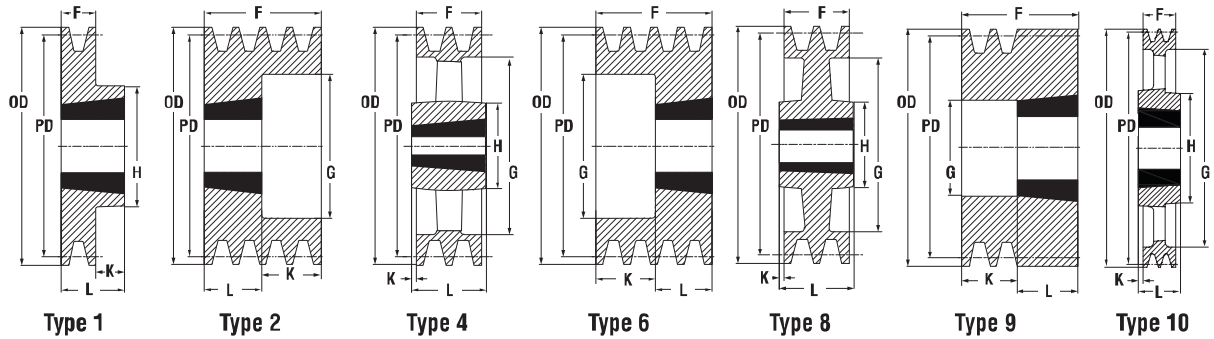

Dimensions for *Martin* pulleys are listed in the following tables with TB bushings in place. The type of pulley shown below is indicated by a number (1 to 11), and the construction is indicated by suffix number (-1 for solid, -2 for web and -3 for spoked).

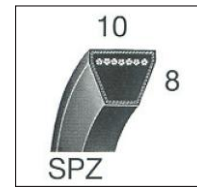

1 Groove F = 16mm											
Part Number	OD	PD SPZ Belt	Type	Bush No.	Max. Bore	F	G	K	L	H	Wt.
1 SPZ 50	54	50	9	1008	25	37	26	14	23	-	0.3
1 SPZ 56	60	56	9	1008	25	37	-	-	37	-	0.5
1 SPZ 60	64	60	9	1008	25	22	-	-	22	-	0.3
1 SPZ 63	67	63	1	1108	28	16	-	6	22	62	0.3
1 SPZ 67	71	67	1	1108	28	16	-	6	22	62	0.3
1 SPZ 71	75	71	1	1108	28	16	-	6	22	62	0.4
1 SPZ 75	79	75	1	1108	28	16	-	6	22	62	0.4
1 SPZ 80	84	80	1	1210	32	16	-	9	25	75	0.5
1 SPZ 85	89	85	1	1210	32	16	-	9	25	86	0.7
1 SPZ 90	94	90	1	1210	32	16	-	9	25	86	0.7
1 SPZ 95	99	95	1	1210	32	16	-	9	25	86	0.8
1 SPZ 100	104	100	1	1210	32	16	-	9	25	86	0.9
1 SPZ 106	110	106	1	1610	42	16	-	9	25	92	1
1 SPZ 112	116	112	1	1610	42	16	-	9	25	92	1.1
1 SPZ 118	122	118	1	1610	42	16	-	9	25	92	1.2
1 SPZ 125	129	125	1	1610	42	16	-	9	25	92	1.3
1 SPZ 132	136	132	1	1610	42	16	-	9	25	92	1.5
1 SPZ 140	144	140	1	1610	42	16	-	9	25	92	1.7
1 SPZ 150	154	150	1	1610	42	16	-	9	25	92	2
1 SPZ 160	164	160	1	1610	42	16	-	9	25	92	2.2
1 SPZ 170	174	170	1	1610	42	16	-	9	25	92	2.2
1 SPZ 180	184	180	8	1610	42	16	152	-	25	92	2.1
1 SPZ 190	194	190	8	1610	42	16	162	-	25	92	2.7
1 SPZ 200	204	200	10	2012	50	16	170	8	32	91	1.9
1 SPZ 212	216	212	10	2012	50	16	182	8	32	91	2.1
1 SPZ 224	228	224	10	2012	50	16	194	8	32	91	2.2
1 SPZ 236	240	236	10	2012	50	16	206	8	32	91	2.4
1 SPZ 250	254	250	10	2012	50	16	220	8	32	91	2.5
1 SPZ 280	284	280	10	2012	50	16	250	8	32	91	2.9
1 SPZ 315	319	315	10	2012	50	16	285	8	32	91	3.2
1 SPZ 355	359	355	10	2012	50	16	325	8	32	91	3.7
1 SPZ 400	404	400	4	2517	60	16	371	8	32	112	6.9
1 SPZ 450	454	450	4	2517	60	16	421	15	45	124	7.2
1 SPZ 500	504	500	4	2517	60	16	470	15	45	124	7.5

2 Groove F = 28mm											
Part Number	OD	PD SPZ Belt	Type	Bush No.	Max. Bore	F	G	K	L	H	Wt.
2 SPZ 50	54	50	9	1008	25	49	26	26	23	-	0.4
2 SPZ 56	60	56	9	1108	28	49	35	27	22	-	0.5
2 SPZ 60	64	60	9	1108	28	49	35	27	22	-	0.7
2 SPZ 63	67	63	2	1108	28	28	40	6	22	-	0.3
2 SPZ 67	71	67	6	1108	28	28	-	-	28	-	0.4
2 SPZ 71	75	71	6	1108	28	28	-	-	28	-	0.5
2 SPZ 75	79	75	6	1210	32	28	-	-	28	-	0.5
2 SPZ 80	84	80	6	1210	32	28	-	-	28	-	0.6
2 SPZ 85	89	85	6	1610	42	28	-	-	28	-	0.6
2 SPZ 90	94	90	6	1610	42	28	-	-	28	-	0.7
2 SPZ 95	99	95	6	1610	42	28	-	-	28	-	0.8
2 SPZ 100	104	100	6	1610	42	28	-	-	28	-	0.9
2 SPZ 106	110	106	6	1610	42	28	-	-	28	-	1.1
2 SPZ 112	116	112	6	1610	42	28	-	-	28	-	1.3
2 SPZ 118	122	118	6	1610	42	28	90	3	25	-	1.5
2 SPZ 125	129	125	6	1610	42	28	97	3	25	-	1.7
2 SPZ 132	136	132	6	1610	42	28	104	3	25	-	2
2 SPZ 140	144	140	6	1610	42	28	112	3	25	-	2.4
2 SPZ 150	154	150	1	2012	50	28	129	4	32	106	2.6
2 SPZ 160	164	160	1	2012	50	28	139	4	32	106	3.1
2 SPZ 170	174	170	8	2012	50	28	142	-	32	106	2.8
2 SPZ 180	184	180	8	2012	50	28	152	-	32	106	2.9
2 SPZ 190	194	190	8	2012	50	28	162	-	32	106	3.1
2 SPZ 200	204	200	10	2012	50	28	170	2	32	91	2.7
2 SPZ 212	216	212	10	2012	50	28	182	2	32	91	2.9
2 SPZ 224	228	224	10	2012	50	28	194	2	32	91	3.1
2 SPZ 236	240	236	10	2012	50	28	206	2	32	91	3.3
2 SPZ 250	254	250	10	2012	50	28	220	2	32	91	3.5
2 SPZ 280	284	280	10	2012	50	28	250	2	32	91	4.1
2 SPZ 315	319	315	10	2012	50	28	285	2	32	91	4.7
2 SPZ 355	359	355	10	2012	50	28	325	2	32	91	5.5
2 SPZ 400	404	400	4	2517	60	28	371	9	45	124	9.9
2 SPZ 450	454	450	4	2517	60	28	421	9	45	124	11.2
2 SPZ 500	504	500	4	2517	60	28	471	9	45	124	12.1
2 SPZ 630	634	630	4	2517	60	28	601	9	45	124	14.7

NOTE: Dimensions in millimeters, weight in kilograms. Weights do not include bushings.

SPZ Taper Bushed Pulley

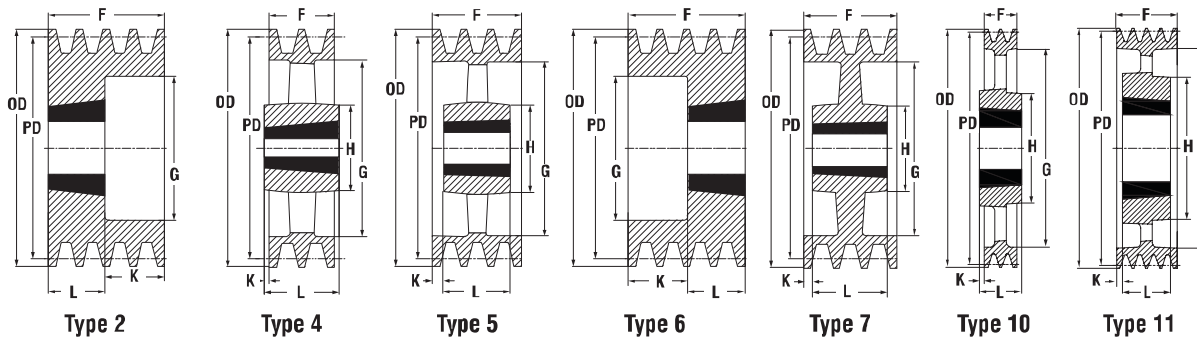

Pulley Groove Dimensions (ISO Standard)

Belt Section	E	S	OD
SPZ	8	12	PD +4

Dimensions in millimeters.
 $F = S(N-1) + 2E$
 N = No. of Grooves

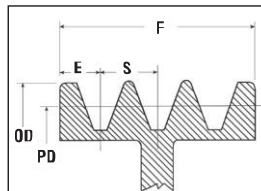

$F = S(N-1) + 2E$
 N = No. of Grooves
 SPZ Taper Bushed Pulley

3 Groove F = 40mm											
Part Number	OD	PD SPZ Belt	Type	Bush No.	Max. Bore	F	G	K	L	H	Wt.
3 SPZ 63	67	63	6	1108	28	40	36	18	22	-	0.4
3 SPZ 67	71	67	6	1108	28	40	38	18	22	-	0.5
3 SPZ 71	75	71	6	1108	28	40	42	18	22	-	0.6
3 SPZ 75	79	75	6	1210	32	40	48	15	25	-	0.7
3 SPZ 80	84	80	6	1210	32	40	52	15	25	-	0.7
3 SPZ 85	89	85	6	1610	42	40	57	15	25	-	0.8
3 SPZ 90	94	90	6	1610	42	40	62	15	25	-	0.9
3 SPZ 95	99	95	6	1610	42	40	67	15	25	-	1
3 SPZ 100	104	100	6	1610	42	40	72	15	25	-	1.1
3 SPZ 106	110	106	6	1610	42	40	78	15	25	-	1.4
3 SPZ 112	116	112	6	2012	50	40	84	8	32	-	1.4
3 SPZ 118	122	118	6	2012	50	40	90	8	32	-	1.7
3 SPZ 125	129	125	2	2012	50	40	96	8	32	-	2
3 SPZ 132	136	132	2	2012	50	40	104	8	32	-	2.3
3 SPZ 140	144	140	2	2012	50	40	112	8	32	-	2.7
3 SPZ 150	154	150	2	2012	50	40	122	8	32	-	3.3
3 SPZ 160	164	160	2	2012	50	40	132	8	32	-	3.9
3 SPZ 170	174	170	7	2012	50	40	142	-	32	106	3.2
3 SPZ 180	184	180	7	2012	50	40	152	-	32	106	3.4
3 SPZ 190	194	190	7	2012	50	40	162	-	32	106	3.4
3 SPZ 200	204	200	11	2012	50	40	170	4	32	91	3.4
3 SPZ 212	216	212	11	2012	50	40	182	4	32	91	3.6
3 SPZ 224	228	224	11	2012	50	40	194	4	32	91	3.9
3 SPZ 236	240	236	11	2012	50	40	206	4	32	91	4.2
3 SPZ 250	254	250	11	2012	50	40	220	4	32	91	4.5
3 SPZ 280	284	280	10	2517	60	40	250	3	45	118	6.3
3 SPZ 315	319	315	10	2517	60	40	285	3	45	118	7.1
3 SPZ 355	359	355	4	2517	60	40	326	3	45	124	11.7
3 SPZ 400	404	400	4	2517	60	40	371	3	45	124	13.3
3 SPZ 450	454	450	4	2517	60	40	421	3	45	124	14.6
3 SPZ 500	504	500	4	2517	60	40	471	3	45	124	15.8
3 SPZ 630	634	630	4	2517	60	40	601	3	45	124	17
3 SPZ 710	714	710	4	3020	75	40	680	6	51	159	25
3 SPZ 800	804	800	4	3020	75	40	771	6	51	159	33

4 Groove F = 52mm											
Part Number	OD	PD SPZ Belt	Type	Bush No.	Max. Bore	F	G	K	L	H	Wt.
4 SPZ 63	67	63	6	1108	28	52	36	30	22	-	0.5
4 SPZ 67	71	67	6	1108	28	52	38	30	22	-	0.6
4 SPZ 71	75	71	6	1108	28	52	42	30	22	-	0.7
4 SPZ 75	79	75	6	1210	32	52	46	27	25	-	0.8
4 SPZ 80	84	80	6	1210	32	52	51	27	25	-	0.9
4 SPZ 85	89	85	6	1610	42	52	56	27	25	-	1
4 SPZ 90	94	90	6	1610	42	52	61	27	25	-	1.1
4 SPZ 95	99	95	6	1610	42	52	66	27	25	-	1.3
4 SPZ 100	104	100	6	1610	42	52	74	27	25	-	1.4
4 SPZ 106	110	106	6	1610	42	52	80	27	25	-	1.6
4 SPZ 112	116	112	6	2012	50	52	86	20	32	-	1.7
4 SPZ 118	122	118	6	2012	50	52	89	20	32	-	2
4 SPZ 125	129	125	2	2012	50	52	99	20	32	-	2.3
4 SPZ 132	136	132	2	2012	50	52	103	20	32	-	2.1
4 SPZ 140	144	140	2	2012	50	52	112	20	32	-	3.1
4 SPZ 150	154	150	2	2517	60	52	121	7	45	-	3.8
4 SPZ 160	164	160	2	2517	60	52	131	7	45	-	4.6
4 SPZ 170	174	170	2	2517	65	52	141	7	45	-	5.5
4 SPZ 180	184	180	2	2517	60	52	151	7	45	-	6.3
4 SPZ 190	194	190	3	2517	65	52	160	4	45	-	5.3
4 SPZ 200	204	200	11	2517	60	52	172	4	45	118	5.2
4 SPZ 212	216	212	11	2517	60	52	182	4	45	118	5.5
4 SPZ 224	228	224	11	2517	60	52	194	4	45	118	5.8
4 SPZ 236	240	236	11	2517	60	52	206	4	45	118	6.1
4 SPZ 250	254	250	11	2517	60	52	220	4	45	118	6.5
4 SPZ 280	284	280	11	2517	60	52	250	4	45	118	7.3
4 SPZ 315	319	315	11	2517	60	52	285	4	45	118	8.3
4 SPZ 355	359	355	5	2517	60	52	326	4	45	124	12.8
4 SPZ 400	404	400	5	2517	60	52	371	4	45	124	13.6
4 SPZ 450	454	450	5	3020	75	52	421	1	51	159	14.5
4 SPZ 500	504	500	5	3020	75	52	471	1	51	159	17.3
4 SPZ 630	634	630	5	3020	75	52	601	1	51	145	23
4 SPZ 710	714	710	4	3030	75	52	680	12	76	159	29
4 SPZ 800	804	800	4	3030	75	52	771	12	76	159	36

NOTE: Dimensions in millimeters, weight in kilograms. Weights do not include bushings.

Taper Bushed Pulley **SPZ**

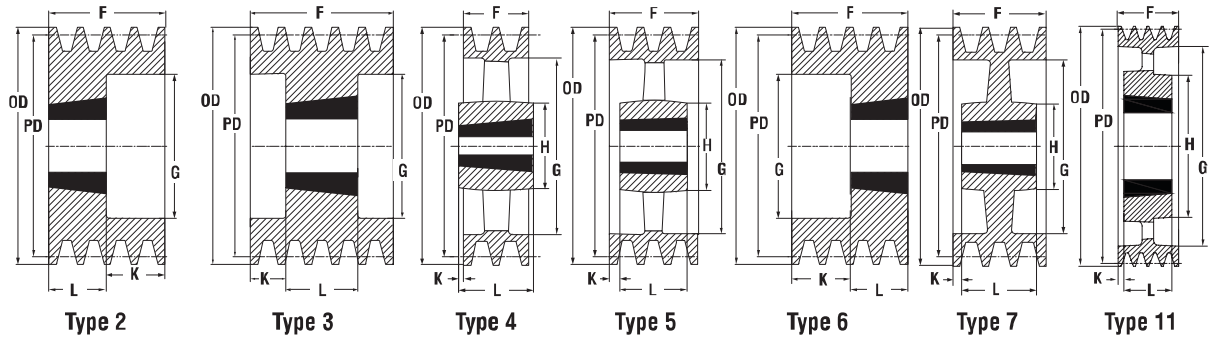

Let *Martin* quote your made to order and large quantity requirements

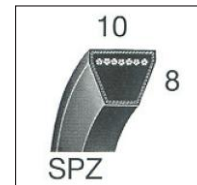

5 Groove F = 64mm											
Part Number	OD	PD SPZ Belt	Type	Bush No.	Max. Bore	F	G	K	L	H	Wt.
5 SPZ 85	89	85	6	1610	42	64	56	39	25	-	1.3
5 SPZ 90	94	90	6	1610	42	64	61	39	25	-	1.3
5 SPZ 95	99	95	6	1610	42	64	66	39	25	-	1.5
5 SPZ 100	104	100	6	2012	50	64	71	32	32	-	1.6
5 SPZ 106	110	106	6	2012	50	64	77	32	32	-	1.8
5 SPZ 112	116	112	6	2012	50	64	83	32	32	-	2
5 SPZ 118	122	118	6	2012	50	64	89	32	32	-	2.3
5 SPZ 125	129	125	6	2012	50	64	96	32	32	-	2.7
5 SPZ 132	136	132	6	2517	60	64	103	19	45	-	2.8
5 SPZ 140	144	140	2	2517	60	64	111	19	45	-	3.4
5 SPZ 150	154	150	2	2517	60	64	121	19	45	-	4.3
5 SPZ 160	164	160	2	2517	60	64	131	19	45	-	5.1
5 SPZ 170	174	170	2	2517	60	64	141	19	45	-	5.7
5 SPZ 180	184	180	2	2517	60	64	151	19	45	-	6.8
5 SPZ 190	194	190	3	2517	60	64	161	10	45	-	7.8
5 SPZ 200	204	200	11	2517	60	64	170	10	45	118	5.8
5 SPZ 212	216	212	11	2517	60	64	182	10	45	118	6.2
5 SPZ 224	228	224	11	2517	60	64	194	10	45	118	6.6
5 SPZ 236	240	236	11	2517	60	64	206	10	45	118	7
5 SPZ 250	254	250	11	2517	60	64	220	10	45	118	7.4
5 SPZ 280	284	280	11	2517	60	64	250	10	45	118	8.4
5 SPZ 315	319	315	11	2517	60	64	285	10	45	118	9.6
5 SPZ 355	359	355	5	2517	60	64	326	10	45	124	13
5 SPZ 400	404	400	5	3020	75	64	371	7	51	159	15.6
5 SPZ 450	454	450	5	3020	75	64	421	7	51	159	19
5 SPZ 500	504	500	5	3020	75	64	471	7	51	159	22.6
5 SPZ 630	634	630	5	3020	75	64	601	7	51	146	29
5 SPZ 710	714	710	4	3535	100	64	684	13	89	191	36.5
5 SPZ 800	804	800	4	3535	100	64	771	13	89	191	44.1

6 Groove F = 76mm											
Part Number	OD	PD SPZ Belt	Type	Bush No.	Max. Bore	F	G	K	L	H	Wt.
6 SPZ 90	95	90	6	1610	42	76	61	-	25	-	1.5
6 SPZ 95	99	95	6	1610	42	76	66	-	25	-	1.7
6 SPZ 100	104	100	6	2012	50	76	71	-	32	-	1.9
6 SPZ 106	110	106	6	2012	50	76	77	-	32	-	2
6 SPZ 112	116	112	6	2012	50	76	83	-	32	-	2.3
6 SPZ 118	122	118	6	2517	60	76	89	-	45	-	2.3
6 SPZ 125	129	125	6	2517	60	76	96	-	45	-	2.7
6 SPZ 132	136	132	6	2517	60	76	103	-	45	-	3.2
6 SPZ 140	144	140	2	2517	60	76	111	31	45	-	3.8
6 SPZ 150	154	150	2	2517	60	76	121	31	45	-	4.6
6 SPZ 160	164	160	2	2517	60	76	131	31	45	-	5.5
6 SPZ 170	174	170	2	2517	65	76	141	31	45	-	6.5
6 SPZ 180	184	180	2	2517	60	76	151	31	45	-	7.3
6 SPZ 190	194	190	3	2517	65	76	161	16	45	-	8.4
6 SPZ 200	204	200	11	2517	60	76	170	16	45	118	6.5
6 SPZ 212	216	212	11	2517	60	76	182	16	45	118	7
6 SPZ 224	228	224	11	2517	60	76	194	16	45	118	7.4
6 SPZ 236	240	236	11	2517	60	76	206	16	45	118	7.9
6 SPZ 250	254	250	11	2517	60	76	220	16	45	118	8.4
6 SPZ 280	284	280	11	2517	60	76	250	16	45	118	9.5
6 SPZ 315	319	315	11	2517	60	76	285	16	45	118	10.8
6 SPZ 355	359	355	5	2517	60	76	326	16	45	124	15
6 SPZ 400	404	400	5	3020	75	76	371	13	51	159	18.3
6 SPZ 450	454	450	5	3020	75	76	421	13	51	159	21.5
6 SPZ 500	504	500	5	3020	75	76	471	13	51	159	24.6
6 SPZ 630	634	630	5	3525	100	76	601	6	65	191	35
6 SPZ 710	714	710	4	3535	100	76	684	7	89	191	46.4
6 SPZ 800	804	800	4	3535	100	76	771	7	89	191	57.9

NOTE: Dimensions in millimeters, weight in kilograms. Weights do not include bushings.

SPZ Taper Bushed Pulley

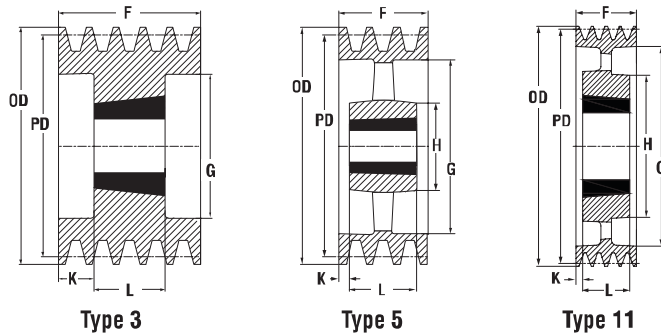

8 Groove F = 100mm

Part Number	OD	PD	SPZ Belt	Type	Bush No.	Max. Bore	F	G	K	L	H	Wt.
8 SPZ 140	144	140	3	2517	65	100	111	28	45	-	4.0	
8 SPZ 150	154	150	3	2517	65	100	121	28	45	-	5.1	
8 SPZ 160	164	160	3	2517	65	100	131	28	45	-	5.6	
8 SPZ 170	174	170	3	2517	65	100	141	28	45	-	6.8	
8 SPZ 180	184	180	3	3020	75	100	151	25	51	-	7.1	
8 SPZ 190	194	190	3	3020	75	100	161	25	51	-	8.2	
8 SPZ 200	204	200	3	3020	75	100	171	25	51	-	9.3	
8 SPZ 212	216	212	3	3020	75	100	192	25	51	-	10.6	
8 SPZ 224	228	224	3	3020	75	100	195	25	51	-	11.8	
8 SPZ 236	240	236	11	3020	75	100	206	25	51	152	11	
8 SPZ 250	254	250	11	3020	75	100	220	25	51	152	11.6	
8 SPZ 280	284	280	11	3020	75	100	250	25	51	152	13.1	
8 SPZ 315	319	315	11	3020	75	100	285	25	51	152	14.9	
8 SPZ 355	359	355	11	3030	75	100	325	12	76	148	18.8	
8 SPZ 400	404	400	5	3030	75	100	371	12	76	145	18.2	
8 SPZ 450	454	450	5	3535	90	100	424	6	89	178	24.0	
8 SPZ 500	504	500	5	3535	90	100	471	6	89	178	26.0	
8 SPZ 630	634	630	5	3535	90	100	601	6	89	178	35.8	

Pulley Groove Dimensions (ISO Standard)

Belt Section	E	S	OD
SPZ	8	12	PD +4

Dimensions in millimeters.
 $F = S(N-1) + 2E$
 N = No. of Grooves

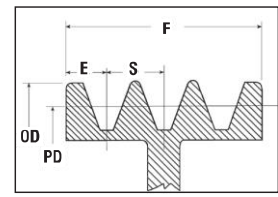

$F = S(N-1) + 2E$
 N = No. of Grooves
 SPZ Taper Bushed Pulley

NOTE: Dimensions in millimeters, weight in kilograms. Weights do not include bushings.



Taper Bushed Pulley SPA

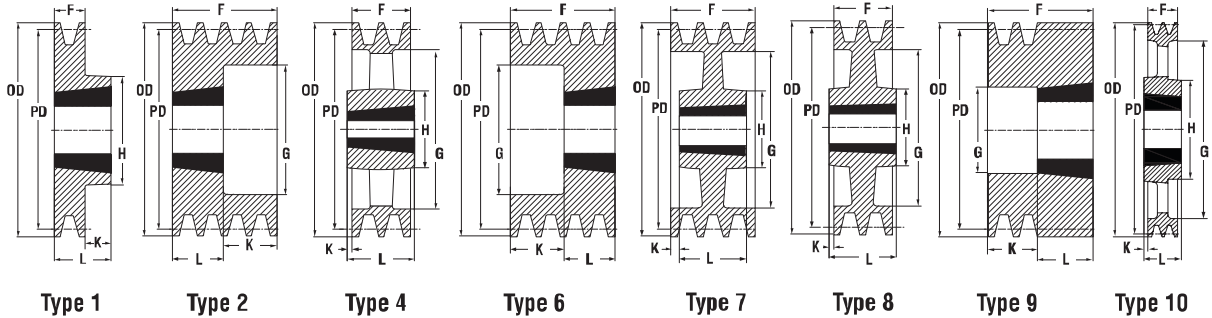

Let *Martin* quote your made to order and large quantity requirements

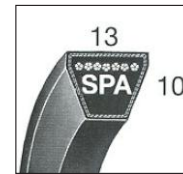

1 Groove F = 16mm											
Part Number	OD	PD SPA Belt	Type	Bush No.	Max. Bore	F	G	K	L	H	Wt.
1 SPA 63	69	63	9	1108	28	40	34	18	22	-	0.8
1 SPA 67	73	67	1	1108	28	20	-	2	22	60	0.5
1 SPA 71	77	71	1	1108	28	20	-	2	22	60	0.5
1 SPA 75	81	75	1	1108	28	20	-	2	22	60	0.4
1 SPA 80	86	80	1	1210	32	20	-	5	25	84	0.5
1 SPA 85	91	85	1	1210	32	20	-	5	25	88	0.6
1 SPA 90	96	90	1	1210	32	20	-	5	25	90	0.7
1 SPA 95	101	95	1	1210	32	20	-	5	25	90	0.9
1 SPA 100	106	100	1	1610	42	20	-	5	25	92	0.8
1 SPA 106	112	106	1	1610	42	20	-	5	25	85	0.9
1 SPA 112	118	112	1	1610	42	20	-	5	25	90	1.1
1 SPA 118	124	118	1	1610	42	20	-	5	25	92	1.2
1 SPA 125	131	125	1	1610	42	20	-	5	25	92	1.4
1 SPA 132	138	132	1	1610	42	20	-	5	25	92	1.6
1 SPA 140	146	140	1	1610	42	20	-	5	25	92	1.8
1 SPA 150	156	150	1	1610	42	20	-	5	25	92	2.1
1 SPA 160	166	160	1	1610	42	20	-	5	25	92	2.4
1 SPA 170	176	170	8	1610	42	20	136	-	25	92	1.1
1 SPA 180	186	180	8	1610	42	20	146	-	25	92	2.3
1 SPA 190	196	190	8	2012	50	20	156	-	32	106	2.7
1 SPA 200	206	200	8	2012	50	20	166	-	32	106	2.3
1 SPA 212	218	212	8	2012	50	20	177	-	32	112	3.5
1 SPA 224	230	224	8	2012	50	20	190	-	32	106	4.0
1 SPA 236	242	236	8	2012	50	20	202	-	32	106	4.4
1 SPA 250	256	250	10	2012	50	20	213	6	32	91	3.1
1 SPA 265	271	265	10	2012	50	20	228	6	32	91	3.4
1 SPA 280	286	280	10	2012	50	20	243	6	32	91	3.6
1 SPA 300	306	300	10	2012	50	20	263	6	32	91	3.9
1 SPA 315	321	315	10	2012	50	20	278	6	32	91	4.2
1 SPA 335	341	335	10	2012	50	20	298	6	32	91	4.5
1 SPA 355	361	355	4	2012	50	20	320	-	32	112	7.6
1 SPA 375	381	375	4	2012	50	20	340	-	32	112	7.8
1 SPA 400	406	400	4	2012	50	20	365	-	32	112	7.9
1 SPA 425	431	425	4	2012	50	20	390	-	32	112	8.2
1 SPA 450	456	450	4	2517	60	20	415	25	45	124	8.4
1 SPA 475	481	475	4	2517	60	20	440	25	45	124	8.9
1 SPA 500	506	500	4	2517	60	20	465	25	45	124	9.4
1 SPA 530	536	530	4	2517	60	20	495	25	45	124	11.0
1 SPA 560	566	560	4	2517	60	20	525	25	45	124	12.6
1 SPA 630	636	630	4	2517	60	20	595	25	45	124	13.1

NOTE: Dimensions in millimeters, weight in kilograms. Weights do not include bushings.

2 Groove F = 28mm											
Part Number	OD	PD SPA Belt	Type	Bush No.	Max. Bore	F	G	K	L	H	Wt.
2 SPA 63	69	63	9	1108	28	55	34	33	22	-	0.6
2 SPA 67	73	67	6	1108	28	35	35	13	22	-	0.4
2 SPA 71	77	71	6	1108	28	35	37	13	22	-	0.5
2 SPA 75	81	75	6	1108	28	35	41	13	22	-	0.7
2 SPA 80	86	80	6	1210	32	35	46	10	25	-	0.6
2 SPA 85	91	85	6	1210	32	35	51	10	25	-	0.7
2 SPA 90	96	90	6	1610	42	35	56	10	25	-	0.7
2 SPA 95	101	95	6	1610	42	35	61	10	25	-	0.9
2 SPA 100	106	100	6	1610	42	35	66	10	25	-	1.1
2 SPA 106	112	106	6	1610	42	35	72	10	25	-	1.2
2 SPA 112	118	112	6	1610	42	35	78	10	25	-	1.4
2 SPA 118	124	118	6	1610	42	35	84	10	25	-	1.6
2 SPA 125	131	125	6	1610	42	35	90	10	25	-	1.9
2 SPA 132	138	132	6	2012	50	35	96	3	32	-	2.1
2 SPA 140	146	140	6	2012	50	35	111	3	32	-	2.6
2 SPA 150	156	150	6	2012	50	35	121	3	32	-	3.2
2 SPA 160	166	160	7	2012	50	35	125	2	32	106	3.8
2 SPA 170	176	170	2	2012	50	35	80	3	32	-	4.5
2 SPA 180	186	180	7	2012	50	35	145	2	32	106	5.2
2 SPA 190	196	190	8	2517	60	35	156	-	45	125	4.4
2 SPA 200	206	200	8	2517	60	35	165	5	45	125	4.9
2 SPA 212	218	212	8	2517	65	35	177	-	45	124	5.8
2 SPA 224	230	224	8	2517	60	35	190	-	45	125	6.6
2 SPA 236	242	236	8	2517	60	35	202	-	45	125	6.8
2 SPA 250	256	250	10	2517	60	35	213	5	45	118	6
2 SPA 265	271	265	10	2517	65	35	228	5	45	118	5.9
2 SPA 280	286	280	10	2517	60	35	243	5	45	118	6.3
2 SPA 300	306	300	10	2517	60	35	263	5	45	118	6.7
2 SPA 315	321	315	10	2517	60	35	278	5	45	118	7.2
2 SPA 335	341	335	10	2517	60	35	298	5	45	118	7.7
2 SPA 355	361	355	4	2517	60	35	320	-	45	124	10.5
2 SPA 375	381	375	4	2517	60	35	340	-	45	124	10.9
2 SPA 400	406	400	4	2517	60	35	365	-	45	124	11.3
2 SPA 425	431	425	4	2517	60	35	390	-	45	124	13.2
2 SPA 450	456	450	4	2517	60	35	415	-	45	124	15.0
2 SPA 475	481	475	4	2517	60	35	440	-	45	124	16.9
2 SPA 500	506	500	4	2517	60	35	465	-	45	124	18.7
2 SPA 530	536	530	4	3020	60	35	495	-	51	124	19.5
2 SPA 560	566	560	4	3020	75	35	525	-	51	159	20.4
2 SPA 630	636	630	4	3020	75	35	595	-	51	159	22.0
2 SPA 710	716	710	4	3020	75	35	675	8	51	159	27.0
2 SPA 800	806	800	4	3525	90	35	764	15	65	191	31.6

SPA Taper Bushed Pulley

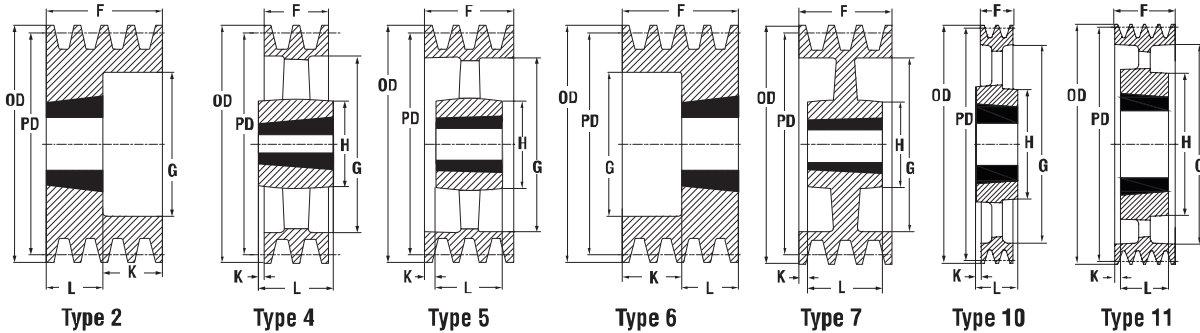

Pulley Groove Dimensions (ISO Standard)

Belt Section	E	S	OD
SPA	10	15	PD +6

Dimensions in millimeters.
 $F = S(N-1) + 2E$
 N = No. of Grooves

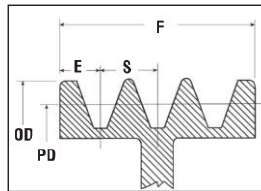

$F = S(N-1) + 2E$
 N = No. of Grooves
 SPZ Taper Bushed Pulley

3 Groove F = 50mm											
Part Number	OD	SPA Belt	Type	Bush No.	Max. Bore	F	G	K	L	H	Wt.
3 SPA 71	77	71	6	1108	28	50	37	28	22	-	0.7
3 SPA 75	81	75	6	1108	28	50	41	28	22	-	0.8
3 SPA 80	86	80	6	1210	32	50	46	25	25	-	0.9
3 SPA 85	91	85	6	1210	32	50	51	25	25	-	1
3 SPA 90	96	90	6	1610	42	50	56	25	25	-	1
3 SPA 95	101	95	6	1610	42	50	61	25	25	-	1.2
3 SPA 100	106	100	2	1610	42	50	66	25	25	-	1.3
3 SPA 106	112	106	2	1610	42	50	71	25	25	-	1.6
3 SPA 112	118	112	6	2012	50	50	78	18	32	-	1.6
3 SPA 118	124	118	2	2012	50	50	84	18	32	-	1.9
3 SPA 125	131	125	2	2012	50	50	91	18	32	-	2.3
3 SPA 132	138	132	2	2012	50	50	98	18	32	-	2.6
3 SPA 140	146	140	6	2517	60	50	111	5	45	-	2.9
3 SPA 150	156	150	6	2517	60	50	116	5	45	-	3.7
3 SPA 160	166	160	6	2517	60	50	126	5	45	-	4.5
3 SPA 170	176	170	2	2517	60	50	136	5	45	-	5
3 SPA 180	186	180	6	2517	60	50	146	5	45	-	6.2
3 SPA 190	196	190	2	2517	60	50	156	5	45	-	7
3 SPA 200	206	200	7	2517	60	50	166	3	45	125	5.6
3 SPA 212	218	212	7	2517	65	50	177	-	45	125	6.6
3 SPA 224	230	224	7	2517	60	50	190	3	45	125	7.5
3 SPA 236	242	236	7	2517	60	50	202	3	45	125	8
3 SPA 250	256	250	11	2517	60	50	213	3	45	118	6.9
3 SPA 265	271	265	11	2517	60	50	228	3	45	118	7.4
3 SPA 280	286	280	11	2517	60	50	243	3	45	118	7.9
3 SPA 300	306	300	10	3020	75	50	263	1	51	152	10
3 SPA 315	321	315	10	3020	75	50	278	1	51	152	10.4
3 SPA 335	341	335	10	3020	75	50	298	1	51	152	11.1
3 SPA 355	361	355	4	3020	75	50	320	1	51	159	13.4
3 SPA 375	381	375	4	3020	75	50	340	1	51	159	14.7
3 SPA 400	406	400	4	3020	75	50	365	1	51	159	15.9
3 SPA 425	431	425	4	3020	75	50	390	1	51	159	17.6
3 SPA 450	456	450	4	3020	75	50	415	1	51	159	19.3
3 SPA 475	481	475	4	3020	75	50	440	1	51	159	20.9
3 SPA 500	506	500	4	3020	75	50	465	1	51	159	22.6
3 SPA 530	536	530	4	3020	75	50	495	1	51	159	23.1
3 SPA 560	566	560	4	3020	75	50	525	1	51	159	23.5
3 SPA 630	636	630	4	3020	75	50	595	1	51	159	27.5
3 SPA 710	716	710	4	3525	100	50	675	8	65	191	37.2
3 SPA 800	806	800	4	3525	100	50	765	8	65	191	40.8
3 SPA 900	906	900	4	3525	100	50	866	8	65	191	43.6
3 SPA 1000	1006	1000	4	3525	100	50	964	8	65	191	50

NOTE: Dimensions in millimeters, weight in kilograms. Weights do not include bushings.

4 Groove F = 65mm											
Part Number	OD	SPA Belt	Type	Bush No.	Max. Bore	F	G	K	L	H	Wt.
4 SPA 90	96	90	6	1610	42	65	60	40	25	-	1.2
4 SPA 95	101	95	6	1610	42	65	61	40	25	-	1.4
4 SPA 100	106	100	2	1610	42	65	66	40	32	-	1.6
4 SPA 106	112	106	6	2012	50	65	72	33	32	-	1.7
4 SPA 112	118	112	6	2012	50	65	78	33	32	-	2
4 SPA 118	124	118	6	2012	50	65	84	33	32	-	2.3
4 SPA 125	131	125	2	2012	50	65	90	33	32	-	2.7
4 SPA 132	138	132	2	2517	60	65	97	20	45	-	2.9
4 SPA 140	146	140	2	2517	60	65	105	20	45	-	3.5
4 SPA 150	156	150	2	2517	60	65	115	20	45	-	4.2
4 SPA 160	166	160	2	2517	60	65	125	20	45	-	5.1
4 SPA 170	176	170	2	2517	60	65	135	20	45	-	6
4 SPA 180	186	180	2	2517	60	65	145	20	45	-	6.9
4 SPA 190	196	190	2	3020	75	65	155	14	51	-	7.2
4 SPA 200	206	200	2	3020	75	65	165	14	51	-	8.4
4 SPA 212	218	212	2	3020	75	65	177	14	51	-	9.9
4 SPA 224	230	224	2	3020	75	65	190	14	51	-	11.4
4 SPA 236	242	236	7	3020	75	65	202	7	51	159	10
4 SPA 250	256	250	11	3020	75	65	213	7	51	152	9.7
4 SPA 265	271	265	11	3020	75	65	228	7	51	152	10.2
4 SPA 280	286	280	11	3020	75	65	243	7	51	152	10.8
4 SPA 300	306	300	11	3020	75	65	263	7	51	152	11.6
4 SPA 315	321	315	11	3020	75	65	278	7	51	152	12.2
4 SPA 335	341	335	11	3020	75	65	298	7	51	152	13
4 SPA 355	361	355	5	3020	75	65	320	7	51	159	15.8
4 SPA 375	381	375	5	3020	75	65	340	7	51	159	16.8
4 SPA 400	406	400	5	3020	75	65	365	7	51	159	17.7
4 SPA 425	431	425	5	3020	75	65	390	7	51	159	20.5
4 SPA 450	456	450	5	3020	75	65	415	7	51	159	23.2
4 SPA 475	481	475	5	3020	75	65	440	7	51	159	25.3
4 SPA 500	506	500	5	3020	75	65	465	7	51	159	27.4
4 SPA 530	536	530	5	3020	75	65	495	7	51	159	29
4 SPA 560	566	560	5	3525	100	65	525	-	65	191	30.5
4 SPA 630	636	630	5	3525	100	65	595	-	65	191	34.1
4 SPA 710	716	710	5	3525	100	65	675	-	65	191	47
4 SPA 800	806	800	5	3525	100	65	765	-	65	191	50.8
4 SPA 900	906	900	4	3525	100	65	866	-	65	191	55.6
4 SPA 1000	1006	1000	4	4040	115	65	964	19	102	215	62

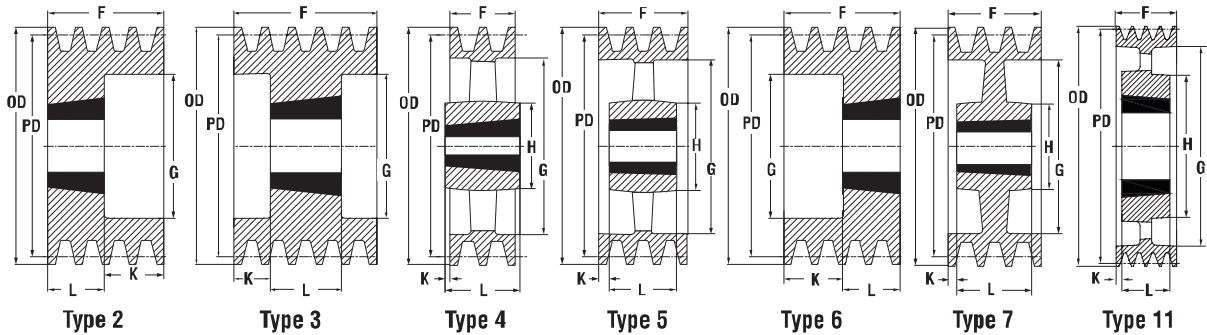

Let *Martin* quote your made to order and large quantity requirements

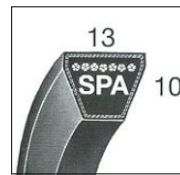

5 Groove F = 80mm											
Part Number	OD	PD SPA Belt	Type	Bush No.	Max. Bore	F	G	K	L	H	Wt.
5 SPA 100	106	100	3	1610	42	80	69	28	25	-	1.9
5 SPA 106	112	106	6	2012	50	80	71	48	32	-	2.1
5 SPA 112	118	112	6	2012	50	80	77	48	32	-	2.4
5 SPA 118	124	118	2	2012	50	80	84	48	32	-	2.7
5 SPA 125	131	125	3	2012	50	80	90	24	32	-	3.1
5 SPA 132	138	132	3	2517	60	80	98	18	45	-	3.2
5 SPA 140	146	140	3	2517	60	80	105	18	45	-	3.9
5 SPA 150	156	150	3	2517	60	80	115	18	45	-	4.7
5 SPA 160	166	160	3	2517	60	80	125	18	45	-	5.6
5 SPA 170	176	170	3	3020	75	80	135	15	51	-	6.2
5 SPA 180	186	180	3	3020	75	80	145	15	51	-	6.8
5 SPA 190	196	190	3	3020	75	80	155	15	51	-	7.4
5 SPA 200	206	200	3	3020	75	80	165	15	51	-	9.1
5 SPA 212	218	212	2	3020	75	80	177	29	51	-	10.7
5 SPA 224	230	224	2	3020	75	80	189	29	51	-	12.3
5 SPA 236	242	236	2	3020	75	80	200	29	51	-	14.2
5 SPA 250	256	250	11	3020	75	80	213	15	51	152	10.9
5 SPA 265	271	265	11	3020	75	80	228	15	51	152	11.6
5 SPA 280	286	280	11	3525	100	80	243	8	65	175	14.4
5 SPA 300	306	300	11	3525	100	80	263	8	65	175	15.3
5 SPA 315	321	315	11	3525	100	80	278	8	65	175	16.1
5 SPA 335	341	335	11	3525	100	80	298	8	65	175	17.1
5 SPA 355	361	355	5	3525	100	80	320	8	65	191	22.8
5 SPA 375	381	375	5	3525	100	80	339	8	65	191	23.8
5 SPA 400	406	400	5	3525	100	80	365	8	65	191	24.8
5 SPA 425	431	425	5	3525	100	80	389	8	65	191	26.7
5 SPA 450	456	450	5	3525	100	80	415	8	65	191	28.5
5 SPA 475	481	475	5	3525	100	80	439	8	65	191	30.1
5 SPA 500	506	500	5	3525	100	80	465	8	65	191	31.7
5 SPA 530	536	530	5	3525	100	80	494	8	65	191	33.3
5 SPA 560	566	560	5	3525	100	80	525	8	65	191	35
5 SPA 630	636	630	5	3525	100	80	595	8	65	191	42
5 SPA 710	716	710	5	4030	115	80	675	2	76	216	56.3
5 SPA 800	806	800	5	4030	115	80	765	2	76	216	60
5 SPA 900	906	900	5	4030	115	80	866	2	76	210	63.7
5 SPA 1000	1006	1000	4	4545	110	80	964	18	115	240	70

6 Groove F = 95mm											
Part Number	OD	PD SPA Belt	Type	Bush No.	Max. Bore	F	G	K	L	H	Wt.
6 SPA 100	106	100	3	1610	42	95	69	35	25	-	2.2
6 SPA 106	112	106	6	2012	50	95	71	63	32	-	2.5
6 SPA 112	118	112	6	2012	50	95	77	63	32	-	2.8
6 SPA 118	124	118	6	2012	50	95	84	63	32	-	3.1
6 SPA 125	131	125	3	2012	50	95	90	32	32	-	3.7
6 SPA 132	138	132	3	2517	60	95	97	25	45	-	3.6
6 SPA 140	146	140	3	2517	60	95	105	25	45	-	4.5
6 SPA 150	156	150	3	2517	60	95	115	25	45	-	5.3
6 SPA 160	166	160	3	2517	60	95	125	25	45	-	6.3
6 SPA 170	176	170	3	3020	75	95	135	22	51	-	6.9
6 SPA 180	186	180	3	3020	75	95	145	22	51	-	7.5
6 SPA 190	196	190	3	3020	75	95	155	22	51	-	8.6
6 SPA 200	206	200	3	3020	75	95	165	22	51	-	9.9
6 SPA 212	218	212	3	3020	75	95	177	22	51	-	11.6
6 SPA 224	230	224	3	3020	75	95	189	22	51	-	13.2
6 SPA 236	242	236	7	3020	75	95	201	22	51	159	12.3
6 SPA 250	256	250	11	3020	75	95	213	22	51	152	12.2
6 SPA 265	271	265	11	3020	75	95	228	22	51	152	13
6 SPA 280	286	280	11	3525	100	95	243	15	65	175	15.9
6 SPA 300	306	300	11	3525	100	95	263	15	65	175	17
6 SPA 315	321	315	11	3525	100	95	278	15	65	175	17.8
6 SPA 335	341	335	11	3525	100	95	298	15	65	175	18.9
6 SPA 355	361	355	5	3525	100	95	320	15	65	191	23.5
6 SPA 375	381	375	5	3525	100	95	339	15	65	191	24.8
6 SPA 400	406	400	5	3525	100	95	365	15	65	191	26
6 SPA 425	431	425	5	3525	100	95	389	15	65	191	28
6 SPA 450	456	450	5	3525	100	95	415	15	65	191	30
6 SPA 475	481	475	5	3525	100	95	439	15	65	191	32
6 SPA 500	506	500	5	3525	100	95	465	15	65	191	34
6 SPA 530	536	530	5	3525	100	95	494	15	65	191	36.5
6 SPA 560	566	560	5	3525	100	95	524	15	65	191	39
6 SPA 630	636	630	5	4030	115	95	595	10	76	216	53.5
6 SPA 710	716	710	5	4030	115	95	675	10	76	216	65
6 SPA 800	806	800	5	4030	115	95	765	10	76	216	70
6 SPA 900	906	900	5	4030	115	95	866	10	76	216	75.5
6 SPA 1000	1006	1000	4	4545	110	95	965	10	115	240	85.5

NOTE: Dimensions in millimeters, weight in kilograms. Weights do not include bushings.

SPB Taper Bushed Pulley

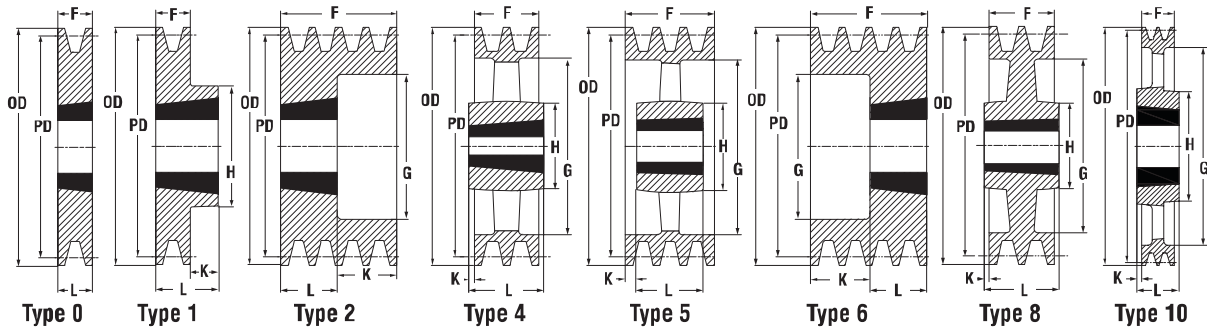

Pulley Groove Dimensions (ISO Standard)

Belt Section	E	S	OD
SPB	12.5	19	PD +7

Dimensions in millimeters.
 $F = S(N-1) + 2E$
 N = No. of Grooves

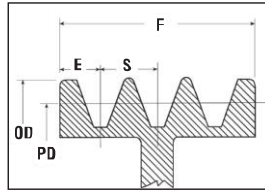

$F = S(N-1) + 2E$
 N = No. of Grooves
 SPZ Taper Bushed Pulley

1 Groove F = 25mm												
Part Number	OD	PD SPB Belt	Type	Bush No.	Max. Bore	F	G	K	L	H	Wt.	
1 SPB 100	107	100	0	1610	42	25	-	-	25	-	0.8	
1 SPB 106	113	106	0	1610	42	25	-	-	25	-	1.0	
1 SPB 112	119	112	0	1610	42	25	-	-	25	-	1.2	
1 SPB 118	125	118	0	1610	42	25	-	-	25	-	1.5	
1 SPB 125	132	125	0	1610	42	25	-	-	25	-	1.5	
1 SPB 132	139	132	0	1610	42	25	-	-	25	-	1.8	
1 SPB 140	147	140	0	1610	42	25	-	-	25	-	2.1	
1 SPB 150	157	150	0	1610	42	25	-	-	25	-	2.5	
1 SPB 160	167	160	0	1610	42	25	-	-	25	-	2.9	
1 SPB 170	177	170	0	1610	42	25	-	-	25	-	3.0	
1 SPB 180	187	180	0	1610	42	25	-	-	25	-	3.8	
1 SPB 190	197	190	1	2012	50	25	-	-	32	112	4.4	
1 SPB 200	207	200	8	2012	50	25	157	-	32	106	4.0	
1 SPB 212	219	212	8	2012	50	25	169	-	32	106	5.2	
1 SPB 224	231	224	8	2012	50	25	181	-	32	106	5.2	
1 SPB 236	243	236	8	2012	50	25	193	-	32	106	5.4	
1 SPB 250	257	250	10	2012	50	25	211	4	32	91	3.6	
1 SPB 265	272	265	10	2012	50	25	226	4	32	91	3.9	
1 SPB 280	287	280	10	2012	50	25	241	4	32	91	4.2	
1 SPB 300	307	300	10	2012	50	25	261	4	32	91	4.6	
1 SPB 315	322	315	10	2012	50	25	276	4	32	91	4.9	
1 SPB 335	342	335	10	2517	60	25	296	10	45	118	6.3	
1 SPB 355	362	355	10	3020	75	25	316	13	51	152	8.2	
1 SPB 375	382	375	10	3020	75	25	336	13	51	152	8.7	
1 SPB 400	407	400	10	3020	75	25	361	13	51	152	9.1	
1 SPB 425	432	425	4	3020	75	25	378	13	51	152	11.5	
1 SPB 450	457	450	4	3020	75	25	407	13	51	146	12.3	
1 SPB 475	482	475	4	3020	75	25	432	13	51	146	13.4	
1 SPB 500	507	500	4	3020	75	25	457	13	51	146	14.6	
1 SPB 530	537	530	4	3020	75	25	484	13	51	146	15.2	
1 SPB 560	567	560	4	3020	75	25	517	13	51	146	18.5	
1 SPB 630	637	630	4	3020	75	25	583	13	51	146	20.5	

2 Groove F = 44mm												
Part Number	OD	PD SPB Belt	Type	Bush No.	Max. Bore	F	G	K	L	H	Wt.	
2 SPB 100	107	100	6	1610	42	44	60	19	25	-	1.3	
2 SPB 106	113	106	6	1610	42	44	65	19	25	-	1.5	
2 SPB 112	119	112	2	2012	50	44	69	12	32	-	1.5	
2 SPB 118	125	118	2	2012	50	44	76	12	32	-	1.7	
2 SPB 125	132	125	2	2012	50	44	90	12	32	-	2	
2 SPB 132	139	132	2	2012	50	44	89	12	32	-	2.4	
2 SPB 140	147	140	2	2012	50	44	97	12	32	-	2.8	
2 SPB 150	157	150	2	2012	50	44	107	12	32	-	3.3	
2 SPB 160	167	160	2	2012	50	44	117	12	32	-	4	
2 SPB 170	177	170	2	2012	50	44	127	12	32	-	4.4	
2 SPB 180	187	180	1	2517	60	44	-	1	45	120	5.5	
2 SPB 190	197	190	1	2517	60	44	-	1	45	120	6.5	
2 SPB 200	207	200	1	2517	60	44	-	1	45	124	7.5	
2 SPB 212	219	212	8	2517	60	44	169	-	45	125	7	
2 SPB 224	231	224	8	2517	60	44	181	1	45	125	7.7	
2 SPB 236	243	236	8	2517	60	44	193	1	45	125	8.3	
2 SPB 250	257	250	10	2517	60	44	211	1	45	125	6.4	
2 SPB 265	272	265	10	2517	60	44	226	1	45	125	6.9	
2 SPB 280	287	280	10	2517	60	44	241	1	45	125	7.2	
2 SPB 300	307	300	10	2517	60	44	261	1	45	125	7.8	
2 SPB 315	322	315	10	2517	60	44	276	1	45	125	8.2	
2 SPB 335	342	335	10	2517	60	44	296	1	45	125	8.8	
2 SPB 355	362	355	10	3020	75	44	316	4	51	146	11	
2 SPB 375	382	375	10	3020	75	44	336	4	51	146	11.5	
2 SPB 400	407	400	10	3020	75	44	361	4	51	146	12.3	
2 SPB 425	432	425	4	3020	75	44	382	4	51	155	16	
2 SPB 450	457	450	4	3020	75	44	407	4	51	146	16.3	
2 SPB 475	482	475	4	3020	75	44	432	4	51	146	17.5	
2 SPB 500	507	500	4	3020	75	44	457	4	51	146	18.6	
2 SPB 530	537	530	4	3020	75	44	484	4	51	146	19.2	
2 SPB 560	567	560	4	3020	75	44	517	4	51	146	22.5	
2 SPB 630	637	630	4	3020	75	44	587	4	51	146	25.5	
2 SPB 710	717	710	4	3020	75	44	664	4	51	145	28	
2 SPB 800	807	800	4	3525	100	44	753	11	65	191	32.1	

NOTE: Dimensions in millimeters, weight in kilograms. Weights do not include bushings.

D-10

Martin

Taper Bushed Pulley **SPB**

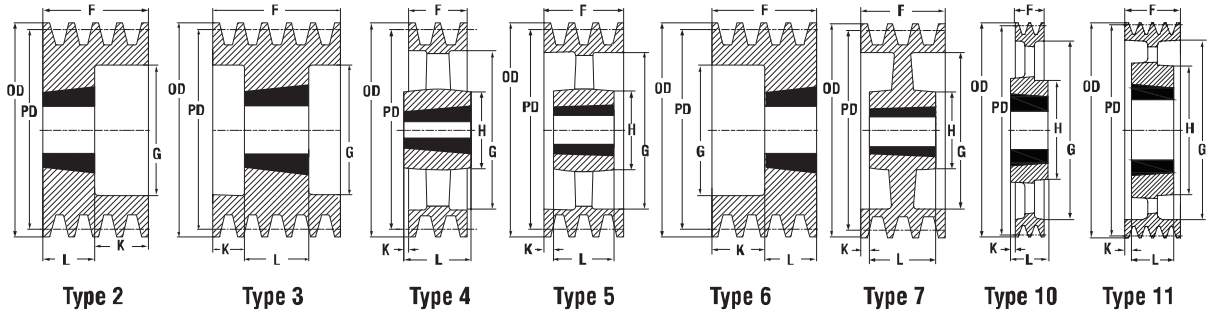

Let *Martin* quote your made to order and large quantity requirements

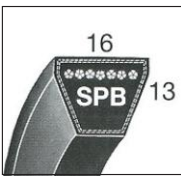

3 Groove F = 63mm											
Part Number	OD	PD SPB Bell	Type	Bush No.	Max. Bore	F	G	K	L	H	Wt.
3 SPB 100	107	100	6	1610	42	63	60	38	25	-	0.9
3 SPB 106	113	106	6	1610	42	63	65	38	25	-	2.0
3 SPB 112	119	112	2	2012	50	63	72	31	32	-	2.0
3 SPB 118	125	118	2	2012	50	63	80	31	32	-	2.3
3 SPB 125	132	125	2	2012	50	63	82	31	32	-	2.5
3 SPB 132	139	132	2	2012	50	63	89	31	32	-	3.1
3 SPB 140	147	140	2	2012	50	63	97	31	32	-	3.5
3 SPB 150	157	150	2	2517	60	63	107	18	45	-	4.0
3 SPB 160	167	160	2	2517	60	63	117	18	45	-	4.9
3 SPB 170	177	170	2	2517	60	63	127	18	45	-	5.7
3 SPB 180	187	180	2	2517	60	63	137	18	45	-	6.7
3 SPB 190	197	190	2	2517	60	63	147	18	45	-	7.6
3 SPB 200	207	200	2	2517	60	63	157	18	45	-	8.9
3 SPB 212	219	212	7	2517	60	63	169	-	45	125	8.2
3 SPB 224	231	224	7	2517	60	63	181	-	45	125	9.1
3 SPB 236	243	236	7	2517	60	63	193	-	45	125	9.8
3 SPB 250	257	250	11	3020	75	63	211	6	51	152	9.4
3 SPB 265	272	265	11	3020	75	63	226	6	51	152	9.9
3 SPB 280	287	280	11	3020	75	63	241	6	51	152	10.5
3 SPB 300	307	300	11	3020	75	63	261	6	51	152	11.3
3 SPB 315	322	315	11	3020	75	63	276	6	51	152	11.8
3 SPB 335	342	335	11	3020	75	63	296	6	51	152	12.6
3 SPB 355	362	355	11	3020	75	63	316	6	51	152	13.5
3 SPB 375	382	375	10	3525	100	63	336	1	65	175	16.5
3 SPB 400	407	400	10	3525	100	63	361	1	65	175	17.4
3 SPB 425	432	425	4	3525	100	63	381	1	65	191	25.7
3 SPB 450	457	450	4	3525	100	63	407	1	65	191	26.3
3 SPB 475	482	475	4	3525	100	63	431	1	65	191	28.1
3 SPB 500	507	500	4	3525	100	63	457	1	65	191	29.9
3 SPB 530	537	530	4	3525	100	63	484	1	65	191	33.6
3 SPB 560	567	560	4	3525	100	63	517	1	65	191	37.2
3 SPB 630	637	630	4	3525	100	63	587	1	65	191	41.0
3 SPB 710	717	710	4	3525	100	63	667	1	65	191	48.0
3 SPB 800	807	800	4	3525	100	63	757	1	65	191	55.0
3 SPB 900	907	900	4	3525	100	63	857	1	65	191	64.1
3 SPB 1000	1007	1000	4	4030	115	63	957	7	76	215	72.0
3 SPB 1120	1127	1120	4	4030	115	63	1077	7	76	215	110.5
3 SPB 1250	1257	1250	4	5040	125	63	1207	20	102	265	140.0

4 Groove F = 82mm												
Part Number	OD	PD SPB Bell	Type	Bush No.	Max. Bore	F	G	K	L	H	Wt.	
4 SPB 100	107	100	3	1210	32	82	82	58	29	25	-	2.4
4 SPB 106	113	106	3	1610	42	82	82	65	29	25	-	2.3
4 SPB 112	119	112	3	1610	42	82	69	29	25	-	2.8	
4 SPB 118	125	118	3	1610	42	82	75	29	25	-	3.3	
4 SPB 125	132	125	3	2012	50	82	82	25	32	-	3.0	
4 SPB 132	139	132	3	2012	50	82	89	25	32	-	3.8	
4 SPB 140	147	140	3	2517	60	82	98	19	45	-	4.0	
4 SPB 150	157	150	3	2517	60	82	107	19	45	-	4.9	
4 SPB 160	167	160	3	2517	60	82	117	19	45	-	5.8	
4 SPB 170	177	170	3	2517	60	82	127	19	45	-	6.6	
4 SPB 180	187	180	3	2517	60	82	137	19	45	-	7.7	
4 SPB 190	197	190	3	2517	60	82	147	19	45	-	8.6	
4 SPB 200	207	200	3	3020	75	82	157	16	51	-	9.3	
4 SPB 212	219	212	3	3020	75	82	169	16	51	-	10.9	
4 SPB 224	231	224	3	3020	75	82	181	16	51	-	12.4	
4 SPB 236	243	236	3	3020	75	82	193	16	51	-	14.1	
4 SPB 250	257	250	11	3020	75	82	211	16	51	152	11	
4 SPB 265	272	265	11	3020	75	82	226	16	51	152	11.7	
4 SPB 280	287	280	11	3020	75	82	241	16	51	152	12.4	
4 SPB 300	307	300	11	3525	100	82	261	9	65	175	15.4	
4 SPB 315	322	315	11	3525	100	82	276	9	65	175	16.1	
4 SPB 335	342	335	11	3525	100	82	296	9	65	175	17.1	
4 SPB 355	362	355	11	3525	100	82	316	9	65	175	18.1	
4 SPB 375	382	375	11	3525	100	82	336	9	65	175	19.1	
4 SPB 400	407	400	11	3525	100	82	361	9	65	175	20.5	
4 SPB 425	432	425	5	3525	100	82	381	9	65	191	28.1	
4 SPB 450	457	450	5	3525	100	82	407	9	65	191	29.7	
4 SPB 475	482	475	5	3525	100	82	431	9	65	191	32.2	
4 SPB 500	507	500	5	3525	100	82	457	9	65	191	34.7	
4 SPB 530	537	530	5	3525	100	82	484	9	65	191	36.9	
4 SPB 560	567	560	5	3525	100	82	517	9	65	191	39.0	
4 SPB 630	637	630	5	3525	100	82	587	9	65	191	44.5	
4 SPB 710	717	710	5	3525	100	82	667	9	65	191	50.5	
4 SPB 800	807	800	5	4030	115	82	757	3	76	215	60.5	
4 SPB 900	907	900	5	4030	115	82	857	3	76	215	70.0	
4 SPB 1000	1007	1000	5	4030	115	82	957	3	76	215	76.5	
4 SPB 1120	1127	1120	5	4030	115	82	1077	3	76	215	121.7	
4 SPB 1250	1257	1250	4	5040	125	82	1207	10	102	265	162.0	

SPB Taper Bushed Pulley

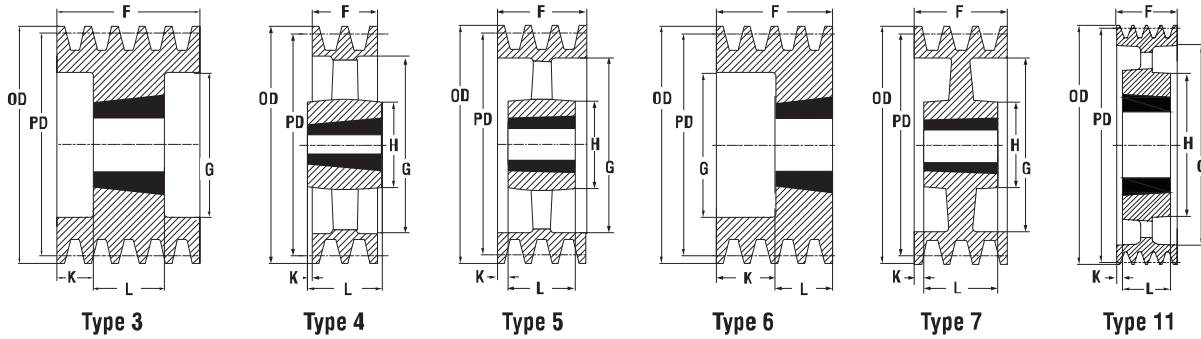

Pulley Groove Dimensions (ISO Standard)

Belt Section	E	S	OD
SPB	12.5	19	PD + 7

Dimensions in millimeters.
 $F = S(N-1) + 2E$
 N = No. of Grooves

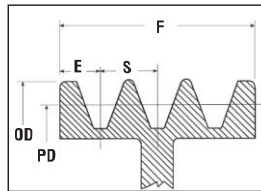

$F = S(N-1) + 2E$
 N = No. of Grooves
 SPZ Taper Bushed Pulley

5 Groove F = 101mm											
Part Number	OD	PD SPB Belt	Type	Bush No.	Max. Bore	F	G	K	L	H	Wt.
5 SPB 100	107	100	3	1615	42	101	60	32	38	-	2.8
5 SPB 106	113	106	3	1615	42	101	65	32	38	-	3.0
5 SPB 112	119	112	3	1615	42	101	69	32	38	-	3.2
5 SPB 118	125	118	3	1615	42	101	71	32	38	-	3.4
5 SPB 125	132	125	6	2012	50	101	82	69	32	-	3.6
5 SPB 132	139	132	6	2517	60	101	89	56	45	-	3.8
5 SPB 140	147	140	3	2517	50	101	106	28	45	-	4.2
5 SPB 150	157	150	3	2517	60	101	107	28	45	-	5.7
5 SPB 160	167	160	3	2517	60	101	117	28	45	-	6.7
5 SPB 170	177	170	3	3020	75	101	127	25	51	-	6.7
5 SPB 180	187	180	3	3020	75	101	137	25	51	-	7.8
5 SPB 190	197	190	3	3020	75	101	147	25	51	-	9.1
5 SPB 200	207	200	3	3020	75	101	157	25	51	-	10.3
5 SPB 212	219	212	3	3020	75	101	169	25	51	-	12.2
5 SPB 224	231	224	3	3020	75	101	181	25	51	-	13.7
5 SPB 236	243	236	3	3525	100	101	193	18	65	-	15.9
5 SPB 250	257	250	3	3525	100	101	207	18	65	-	18.6
5 SPB 265	272	265	7	3525	100	101	224	18	65	191	20.0
5 SPB 280	287	280	11	3525	100	101	241	18	65	175	16.4
5 SPB 300	307	300	11	3525	100	101	261	18	65	175	17.4
5 SPB 315	322	315	11	3525	100	101	276	18	65	175	18.3
5 SPB 335	342	335	11	3525	100	101	296	18	65	175	19.5
5 SPB 355	362	355	11	3525	100	101	316	18	65	175	20.7
5 SPB 375	382	375	11	3525	100	101	336	18	65	175	21.9
5 SPB 400	407	400	11	3525	100	101	361	18	65	175	23.4
5 SPB 425	432	425	5	3525	100	101	381	18	65	191	31.0
5 SPB 450	457	450	5	3525	100	101	407	18	65	191	32.8
5 SPB 475	482	475	5	3525	100	101	431	18	65	191	34.7
5 SPB 500	507	500	5	3525	100	101	457	18	65	191	36.7
5 SPB 530	537	530	5	3525	100	101	484	18	65	191	41.1
5 SPB 560	567	560	5	3525	100	101	517	18	65	191	45.6
5 SPB 630	637	630	5	3525	100	101	587	18	65	191	50.0
5 SPB 710	717	710	5	4030	115	101	667	13	76	215	63.5
5 SPB 800	807	800	5	4030	115	101	757	13	76	215	67.0
5 SPB 900	907	900	5	4535	115	101	857	6	89	240	103.0
5 SPB 1000	1007	1000	5	4535	125	101	957	6	89	240	110.0
5 SPB 1120	1127	1120	5	4535	125	101	1077	6	89	240	143.0
5 SPB 1250	1257	1250	4	5040	125	101	1207	1	102	265	180.0

6 Groove F = 120mm											
Part Number	OD	PD SPB Belt	Type	Bush No.	Max. Bore	F	G	K	L	H	Wt.
6 SPB 100	107	100	3	1615	42	120	60	41	38	-	3.0
6 SPB 106	113	106	3	1615	42	120	65	41	38	-	3.3
6 SPB 112	119	112	3	1615	42	120	69	41	38	-	3.6
6 SPB 118	125	118	3	1615	42	120	71	41	38	-	3.9
6 SPB 125	132	125	3	2012	50	120	85	44	32	-	4.2
6 SPB 132	139	132	3	2012	50	120	89	44	32	-	4.5
6 SPB 140	147	140	3	2517	60	120	97	38	45	-	4.7
6 SPB 150	157	150	3	2517	60	120	107	38	45	-	6.5
6 SPB 160	167	160	3	3020	75	120	123	35	51	-	5.9
6 SPB 170	177	170	3	3020	75	120	127	35	51	-	7.6
6 SPB 180	187	180	3	3020	75	120	137	35	51	-	8.9
6 SPB 190	197	190	3	3020	75	120	147	35	51	-	10.2
6 SPB 200	207	200	3	3020	75	120	157	35	51	-	11.7
6 SPB 212	219	212	3	3525	100	120	169	28	65	-	13.2
6 SPB 224	231	224	3	3525	100	120	181	28	65	-	15.2
6 SPB 236	243	236	3	3525	100	120	193	28	65	-	17.6
6 SPB 250	257	250	3	3525	100	120	207	28	65	-	20.2
6 SPB 265	272	265	7	3525	100	120	224	28	65	191	21.8
6 SPB 280	287	280	11	3525	100	120	241	28	65	175	18.1
6 SPB 300	307	300	11	3525	100	120	261	28	65	175	19.5
6 SPB 315	322	315	11	3525	100	120	276	28	65	175	20.6
6 SPB 335	342	335	11	3525	100	120	296	28	65	175	21.7
6 SPB 355	362	355	11	3525	100	120	316	28	65	175	23.2
6 SPB 375	382	375	11	3525	100	120	336	28	65	175	24.6
6 SPB 400	407	400	11	3525	100	120	361	28	65	175	26.3
6 SPB 425	432	425	5	3525	100	120	381	28	65	191	33.6
6 SPB 450	457	450	5	3525	100	120	407	28	65	191	35.3
6 SPB 475	482	475	5	3525	100	120	431	28	65	191	38.0
6 SPB 500	507	500	5	3525	100	120	457	28	65	191	40.7
6 SPB 530	537	530	5	3525	100	120	484	28	65	191	45.0
6 SPB 560	567	560	5	3525	100	120	517	28	65	191	49.2
6 SPB 630	637	630	5	3525	100	120	587	28	65	191	53.5
6 SPB 710	717	710	5	4535	125	120	667	16	89	240	69.0
6 SPB 800	807	800	5	4535	125	120	757	16	89	240	84.5
6 SPB 900	907	900	5	4535	125	120	857	16	89	240	94.5
6 SPB 1000	1007	1000	5	4535	125	120	957	16	89	240	104.0
6 SPB 1120	1127	1120	5	4535	125	120	1077	16	89	240	170.0
6 SPB 1250	1257	1250	5	5040	125	120	1207	9	102	265	210.0

NOTE: Dimensions in millimeters, weight in kilograms. Weights do not include bushings.

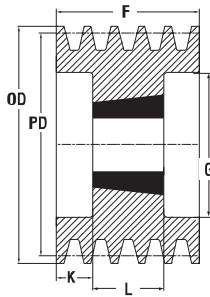

Type 3

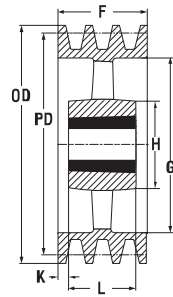

Type 5

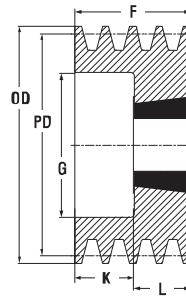

Type 6

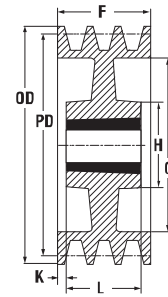

Type 7

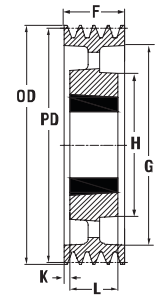

Type 11

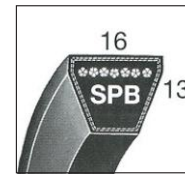

8 Groove F = 158mm											
Part Number	OD	PD SPB Belt	Type	Bush No.	Max. Bore	F	G	K	L	H	Wt.
8 SPB 160	167	160	3	3020	75	158	117	54	51	-	8.3
8 SPB 170	177	170	3	3020	75	158	123	54	51	-	9.5
8 SPB 180	187	180	3	3020	75	158	137	54	51	-	10.8
8 SPB 190	197	190	3	3020	75	158	147	54	51	-	12.3
8 SPB 200	207	200	3	3525	100	158	157	47	65	-	13.7
8 SPB 212	219	212	3	3525	100	158	169	47	65	-	15.8
8 SPB 224	231	224	3	3525	100	158	181	47	65	-	17.9
8 SPB 236	243	236	3	3525	100	158	193	47	65	-	20.0
8 SPB 250	257	250	3	3525	100	158	207	47	65	-	23.2
8 SPB 265	272	265	3	3525	100	158	218	47	65	-	25.0
8 SPB 280	287	280	11	3525	100	158	241	47	65	175	22.2
8 SPB 300	307	300	11	3525	100	158	261	47	65	175	23.8
8 SPB 315	322	315	11	3525	100	158	276	47	65	175	25
8 SPB 335	342	335	11	3525	100	158	296	47	65	175	26.5
8 SPB 355	362	355	11	3525	100	158	316	47	65	175	28.4
8 SPB 375	382	375	11	3525	100	158	336	47	65	175	30.1
8 SPB 400	407	400	11	3525	100	158	361	47	65	175	32.6
8 SPB 425	432	425	11	3525	100	158	386	47	65	175	35
8 SPB 450	457	450	5	3525	100	158	396	47	65	191	46.0
8 SPB 475	482	475	5	3525	100	158	432	47	65	191	49.5
8 SPB 500	507	500	5	3525	100	158	457	47	65	191	52.0
8 SPB 530	537	530	5	4030	115	158	484	41	76	215	53.0
8 SPB 560	567	560	5	4030	115	158	487	41	76	215	54.5
8 SPB 630	637	630	5	4030	115	158	590	41	76	215	67.0
8 SPB 710	717	710	5	4535	125	158	667	35	89	240	75.5
8 SPB 800	807	800	5	4535	125	158	757	35	89	240	94.5
8 SPB 900	907	900	5	4535	125	158	857	35	89	240	113.5
8 SPB 1000	1007	1000	5	5040	125	158	957	28	102	265	121.5
8 SPB 1120	1127	1120	5	5040	125	158	1077	28	102	265	182.2
8 SPB 1250	1257	1250	5	5040	125	158	1207	28	102	265	242.0

10 Groove F = 196mm											
Part Number	OD	PD SPB Belt	Type	Bush No.	Max. Bore	F	G	K	L	H	Wt.
10 SPB 224	231	224	3	3535	90	196	181	54	89	-	20.5
10 SPB 236	243	236	3	3535	90	196	193	54	89	-	22.6
10 SPB 250	257	250	3	3535	90	196	207	54	89	-	26.6
10 SPB 280	287	280	3	3535	90	196	229	54	89	191	27.8
10 SPB 315	322	315	3	3535	90	196	265	54	89	191	28.8
10 SPB 335	342	335	7	4040	100	196	292	47	102	210	32.0
10 SPB 355	362	355	7	4040	100	196	310	47	102	210	33.5
10 SPB 400	407	400	7	4040	100	196	357	47	102	210	36.0
10 SPB 450	457	450	5	4545	110	196	407	41	115	240	47.0
10 SPB 500	507	500	5	4545	110	196	449	41	115	240	55.0
10 SPB 630	637	630	5	4545	110	196	587	41	115	240	66.0
10 SPB 710	717	710	5	4545	125	196	667	41	115	240	75.0
10 SPB 800	807	800	5	4545	125	196	757	41	115	240	96.0
10 SPB 900	907	900	5	5050	125	196	853	35	127	265	119.0
10 SPB 1000	1007	1000	5	5050	125	196	954	35	127	265	141.0
10 SPB 1120	1127	1120	5	5050	125	196	1077	35	127	265	200.0
10 SPB 1250	1257	1250	5	5050	125	196	1203	35	127	265	265.0

NOTE: Dimensions in millimeters, weight in kilograms. Weights do not include bushings.

SPC Taper Bushed Pulley

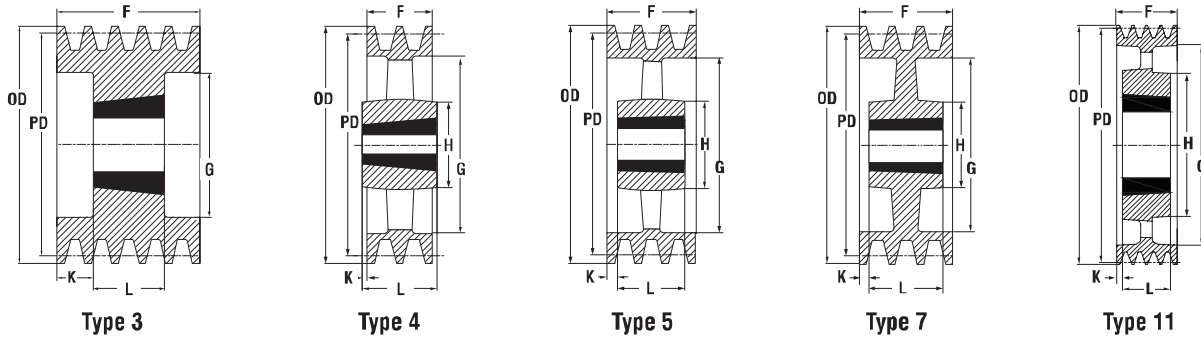

Pulley Groove Dimensions (ISO Standard)

Belt Section	E	S	OD
SPC	17	25.5	PD +10

Dimensions in millimeters.
 $F = S(N-1) + 2E$
 N = No. of Grooves

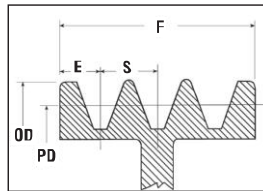

$F = S(N-1) + 2E$
 N = No. of Grooves
 SPZ Taper Bushed Pulley

3 Groove F = 85mm											
Part Number	OD	PD SPC Belt	Type	Bush No.	Max. Bore	F	G	K	L	H	Wt.
3 SPC 200	210	200	3	2517	60	85	144	20	45	-	10.2
3 SPC 212	222	212	3	3020	75	85	156	17	51	-	11.2
3 SPC 224	234	224	3	3020	75	85	168	17	51	-	12.7
3 SPC 236	246	236	3	3020	75	85	180	17	51	-	14.4
3 SPC 250	260	250	3	3020	75	85	194	17	51	-	16.5
3 SPC 265	275	265	3	3525	100	85	209	10	65	-	19.7
3 SPC 280	290	280	3	3525	100	85	224	10	65	-	22.7
3 SPC 300	310	300	11	3525	100	85	244	10	65	175	17.5
3 SPC 315	325	315	11	3525	100	85	259	10	65	175	18.3
3 SPC 335	345	335	11	3525	100	85	279	10	65	175	20.0
3 SPC 355	365	355	11	3525	100	85	299	10	65	175	21.3
3 SPC 375	385	375	11	3525	100	85	319	10	65	175	22.5
3 SPC 400	410	400	11	3525	100	85	344	10	65	175	24.1
3 SPC 425	435	425	5	3525	100	85	369	10	65	191	32.8
3 SPC 450	460	450	5	3525	100	85	394	10	65	191	34.7
3 SPC 475	485	475	5	3525	100	85	419	10	65	191	36.5
3 SPC 500	510	500	5	3525	100	85	444	10	65	191	40.0
3 SPC 530	540	530	5	3525	100	85	474	10	65	191	42.5
3 SPC 560	570	560	5	3525	100	85	504	10	65	191	45.9
3 SPC 630	640	630	5	4030	115	85	574	5	76	215	76.3
3 SPC 710	720	710	5	4030	115	85	654	5	76	215	81.6
3 SPC 800	810	800	4	4535	125	85	744	2	89	240	87.0
3 SPC 900	910	900	4	4535	125	85	840	2	89	240	103.5
3 SPC 1000	1010	1000	4	5040	125	85	940	9	102	265	120.0
3 SPC 1120	1130	1120	4	5040	125	85	1060	9	102	265	147.5
3 SPC 1250	1260	1250	4	5040	125	85	1190	9	102	265	175.0

4 Groove F = 111mm											
Part Number	OD	PD SPC Belt	Type	Bush No.	Max. Bore	F	G	K	L	H	Wt.
4 SPC 200	210	200	3	3020	75	111	144	30	51	-	11.3
4 SPC 212	222	212	3	3020	75	111	156	30	51	-	13.0
4 SPC 224	234	224	3	3525	100	111	168	23	65	-	14.5
4 SPC 236	246	236	3	3525	100	111	180	23	65	-	16.7
4 SPC 250	260	250	3	3525	100	111	194	23	65	-	19.3
4 SPC 265	275	265	3	3525	100	111	209	23	65	-	22.4
4 SPC 280	290	280	3	3525	100	111	224	23	65	-	25.4
4 SPC 300	310	300	11	3525	100	111	244	23	65	175	20.9
4 SPC 315	325	315	11	3525	100	111	259	23	65	175	22.0
4 SPC 335	345	335	11	3525	100	111	279	23	65	175	24.0
4 SPC 355	365	355	11	3525	100	111	299	23	65	175	25.7
4 SPC 375	385	375	11	3525	100	111	319	23	65	175	27.3
4 SPC 400	410	400	11	3525	100	111	344	23	65	175	29.3
4 SPC 425	435	425	5	3525	100	111	369	23	65	191	38.0
4 SPC 450	460	450	5	3525	100	111	394	23	65	191	41.3
4 SPC 475	485	475	5	3525	100	111	419	23	65	191	43.7
4 SPC 500	510	500	5	3525	100	111	444	23	65	191	46.0
4 SPC 530	540	530	5	3525	100	111	474	23	65	191	52.0
4 SPC 560	570	560	5	3525	100	111	504	23	65	191	58.0
4 SPC 630	640	630	5	4030	115	111	574	18	76	215	63.8
4 SPC 710	720	710	5	4535	125	111	654	11	89	240	83.2
4 SPC 800	810	800	5	5040	125	111	744	4	102	265	102.5
4 SPC 900	910	900	5	5040	125	111	840	4	102	265	116.3
4 SPC 1000	1010	1000	5	5040	125	111	940	4	102	265	130.0
4 SPC 1120	1130	1120	5	5040	125	111	1060	4	102	265	158.0
4 SPC 1250	1260	1250	5	5040	125	111	1190	4	102	265	186.0

NOTE: Dimensions in millimeters, weight in kilograms. Weights do not include bushings.

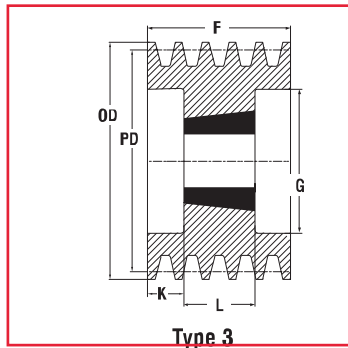

Type 3

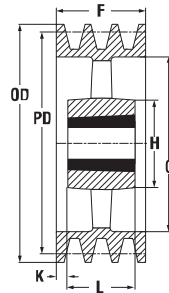

Type 5

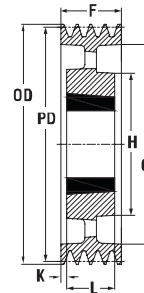

Type 11

Let *Martin* quote your made to order and large quantity requirements

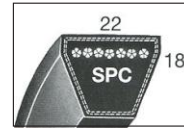

5 Groove F = 136mm											
Part Number	OD	PD SPC Belt	Type	Bush No.	Max. Bore	F	G	K	L	H	Wt.
5 SPC 200	210	200	3	3525	100	136	145	36	65	-	12.2
5 SPC 212	222	212	3	3525	100	136	156	36	65	-	14.5
5 SPC 224	234	224	3	3525	100	136	168	36	65	-	16.6
5 SPC 236	246	236	3	3525	100	136	180	36	65	-	18.9
5 SPC 250	260	250	3	3525	100	136	194	36	65	-	21.5
5 SPC 265	275	265	3	3525	100	136	209	36	65	-	25.0
5 SPC 280	290	280	3	3525	100	136	224	36	65	-	28.4
5 SPC 300	310	300	11	3525	100	136	244	36	65	175	24.7
5 SPC 315	325	315	11	3525	100	136	259	36	65	175	26
5 SPC 335	345	335	11	3525	100	136	279	36	65	175	28.2
5 SPC 355	365	355	11	3525	100	136	299	36	65	175	30.1
5 SPC 375	385	375	11	3525	100	136	319	36	65	175	32.3
5 SPC 400	410	400	11	3525	100	136	344	36	65	175	34.7
5 SPC 425	435	425	5	3525	100	136	369	36	65	191	42.5
5 SPC 450	460	450	5	3525	100	136	394	36	65	191	44.3
5 SPC 475	485	475	5	3525	100	136	419	36	65	191	48.5
5 SPC 500	510	500	5	3525	100	136	444	36	65	191	51.0
5 SPC 530	540	530	5	4535	125	136	474	24	89	240	66.0
5 SPC 560	570	560	5	4535	125	136	504	24	89	240	66.7
5 SPC 630	640	630	5	4535	125	136	574	24	89	240	73.0
5 SPC 710	720	710	5	5040	125	136	654	17	102	265	93.0
5 SPC 800	810	800	5	5040	125	136	744	17	102	265	119.0
5 SPC 900	910	900	5	5040	125	136	840	17	102	265	133.0
5 SPC 1000	1010	1000	5	5040	125	136	940	17	102	265	147.0
5 SPC 1120	1130	1120	5	5040	125	136	1060	17	102	265	178.5
5 SPC 1250	1260	1250	5	5040	125	136	1190	17	102	265	210.0

6 Groove F = 162mm											
Part Number	OD	PD SPC Belt	Type	Bush No.	Max. Bore	F	G	K	L	H	Wt.
6 SPC 200	210	200	3	3525	100	162	144	48	65	-	14.1
6 SPC 212	222	212	3	3525	100	162	156	48	65	-	16.5
6 SPC 224	234	224	3	3525	100	162	168	48	65	-	18.9
6 SPC 236	246	236	3	3525	100	162	180	48	65	-	21.3
6 SPC 250	260	250	3	3525	100	162	194	48	65	-	29.0
6 SPC 265	275	265	3	3525	100	162	209	48	65	-	30.3
6 SPC 280	290	280	3	3525	100	162	224	48	65	-	31.5
6 SPC 300	310	300	11	3525	100	162	244	48	65	175	28.3
6 SPC 315	325	315	11	3525	100	162	259	48	65	175	30.8
6 SPC 335	345	335	11	3525	100	162	279	48	65	175	32.7
6 SPC 355	365	355	11	3525	100	162	299	48	65	175	35.1
6 SPC 375	385	375	11	3525	100	162	319	48	65	175	37.3
6 SPC 400	410	400	11	3525	100	162	344	48	65	175	40.1
6 SPC 425	435	425	5	4535	125	162	369	36	89	240	51.0
6 SPC 450	460	450	5	4535	125	162	394	36	89	240	57.5
6 SPC 475	485	475	5	4535	125	162	419	36	89	240	62.0
6 SPC 500	510	500	5	4535	125	162	444	36	89	240	67.0
6 SPC 530	540	530	5	4535	125	162	474	36	89	240	74.5
6 SPC 560	570	560	5	4535	125	162	504	36	89	240	77.5
6 SPC 630	640	630	5	4535	125	162	574	36	89	240	88.5
6 SPC 710	720	710	5	5040	125	162	654	30	102	265	107.3
6 SPC 800	810	800	5	5040	125	162	744	30	102	265	126.0
6 SPC 900	910	900	5	5040	125	162	840	30	102	265	155.5
6 SPC 1000	1010	1000	5	5040	125	162	940	30	102	265	185.0
6 SPC 1120	1130	1120	5	5040	125	162	1060	30	102	265	221.5
6 SPC 1250	1260	1250	5	5040	125	162	1190	30	102	265	258.0

NOTE: Dimensions in millimeters, weight in kilograms. Weights do not include bushings.

SPC Taper Bushed Pulley

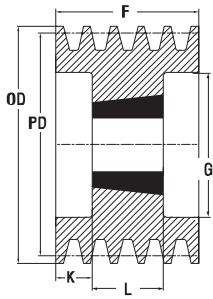

Type 3

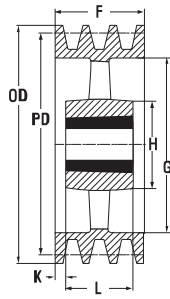

Type 5

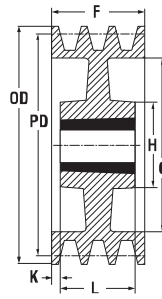

Type 7

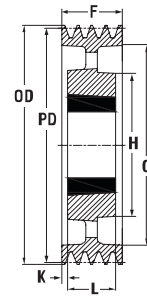

Type 11

Pulley Groove Dimensions (ISO Standard)

Belt Section	E	S	OD
SPC	17	25.5	PD +10

Dimensions in millimeters.
 $F = S(N-1) + 2E$
 N = No. of Grooves

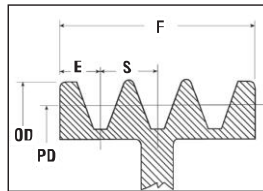

$F = S(N-1) + 2E$
 N = No. of Grooves
 SPZ Taper Bushed Pulley

8 Groove F = 213mm											
Part Number	OD	PD SPC Belt	Type	Bush No.	Max. Bore	F	G	K	L	H	Wt.
8 SPC 200	210	200	3	3525	100	213	144	74	65	-	20.0
8 SPC 212	222	212	3	3525	100	213	156	74	65	-	21.3
8 SPC 224	234	224	3	3525	100	213	168	74	65	-	22.9
8 SPC 236	246	236	3	3525	100	213	180	74	65	-	25.9
8 SPC 250	260	250	3	3525	100	213	194	74	65	-	29.0
8 SPC 265	275	265	3	3525	100	213	209	74	65	-	32.5
8 SPC 280	290	280	3	3525	100	213	224	74	65	-	36.1
8 SPC 300	310	300	7	3525	100	213	244	74	65	191	37.1
8 SPC 315	325	315	11	3525	100	213	259	74	65	175	37.8
8 SPC 335	345	335	11	3525	100	213	279	74	65	175	41.5
8 SPC 355	365	355	11	3525	100	213	299	74	65	175	44.5
8 SPC 375	385	375	11	4030	115	213	319	69	76	205	50.9
8 SPC 400	410	400	11	4030	115	213	344	69	76	205	54.7
8 SPC 425	435	425	5	4535	125	213	369	62	89	240	63.5
8 SPC 450	460	450	5	4535	125	213	394	62	89	240	70.0
8 SPC 475	485	475	5	4535	125	213	419	62	89	240	72.0
8 SPC 500	510	500	5	4535	125	213	444	62	89	240	82.5
8 SPC 530	540	530	5	4535	125	213	474	62	89	240	82.5
8 SPC 560	570	560	5	4535	125	213	504	62	89	240	94.5
8 SPC 630	640	630	5	4535	125	213	574	62	89	240	102.0
8 SPC 710	720	710	5	5040	125	213	654	56	102	265	123.5
8 SPC 800	810	800	5	5040	125	213	744	56	102	265	145.0
8 SPC 900	910	900	5	5040	125	213	840	56	102	265	176.0
8 SPC 1000	1010	1000	5	5040	125	213	940	56	102	265	207.0
8 SPC 1120	1130	1120	5	5040	125	213	1060	56	102	265	246.0
8 SPC 1250	1260	1250	5	5040	125	213	1190	56	102	265	285.0

10 Groove F = 264mm											
Part Number	OD	PD SPC Belt	Type	Bush No.	Max. Bore	F	G	K	L	H	Wt.
10 SPC 224	234	224	3	4040	115	264	168	81	102	-	28.0
10 SPC 236	246	236	3	4040	115	264	180	81	102	-	30.9
10 SPC 250	260	250	3	4040	115	264	194	81	102	-	35.0
10 SPC 265	275	265	3	4040	115	264	209	81	102	-	39.5
10 SPC 280	290	280	3	4040	115	264	224	81	102	-	42.1
10 SPC 300	310	300	3	4040	115	264	244	81	102	-	44.1
10 SPC 315	325	315	3	4545	125	264	259	75	114	-	47.0
10 SPC 335	345	335	3	4545	125	264	279	75	114	-	51.0
10 SPC 355	365	355	3	4545	125	264	299	75	114	-	57.0
10 SPC 375	385	375	3	5050	125	264	319	69	127	-	62.5
10 SPC 400	410	400	7	5050	125	264	344	69	127	265	66.0
10 SPC 425	435	425	7	5050	125	264	369	69	127	265	70.5
10 SPC 450	460	450	7	5050	125	264	394	69	127	265	78.0
10 SPC 475	485	475	7	5050	125	264	419	69	127	265	82.0
10 SPC 500	510	500	7	5050	125	264	444	69	127	265	95.5
10 SPC 530	540	530	7	5050	125	264	474	69	127	265	106.5
10 SPC 560	570	560	5	5050	125	264	504	69	127	265	94.7
10 SPC 630	640	630	5	5050	125	264	574	69	127	265	113.2
10 SPC 710	720	710	5	5050	125	264	647	69	127	265	133.5
10 SPC 800	810	800	5	5050	125	264	737	69	127	265	160.5
10 SPC 900	910	900	5	5050	125	264	840	69	127	265	190.5
10 SPC 1000	1010	1000	5	5050	125	264	937	69	127	265	227.5
10 SPC 1120	1130	1120	5	5050	125	264	1060	69	127	265	266.0
10 SPC 1250	1260	1250	5	5050	125	264	1187	69	127	265	300.0

NOTE: Dimensions in millimeters, weight in kilograms. Weights do not include bushings.



Warning & Safety Reminder

WARNING & SAFETY REMINDER

Safety must be considered a basic factor in machinery operation at all times. Most accidents are the result of carelessness or negligence. All rotating power transmission products are potentially dangerous and must be guarded by the contractor, installer, purchaser, owner, and user as required by applicable laws, regulations, standards, and good safety practice. Additional specific information must be obtained from other sources including the latest editions of American Society of Mechanical Engineers; Standard A.N.S.I. B15.1. A copy of this standard may be obtained from the American Society of Mechanical Engineers at 345 East 47th Street, New York, NY 10017 (212-705-7722).

It is the responsibility of the contractor, installer, purchaser, owner, and user to install, maintain, and operate the parts or components manufactured and supplied by *Martin* Sprocket & Gear, Inc., in such a manner as to comply with the Williams-Steiger Occupational Safety Act and with all state and local laws, ordinances, regulations, and the American National Standard Institute Safety Code.

CAUTION

Guards, access doors, and covers must be securely fastened before operating any equipment.

If parts are to be inspected, cleaned, observed, or general maintenance performed, the motor driving the part or components is to be locked out electrically in such a manner that it cannot be started by anyone, however remote from the area. Failure to follow these instructions may result in personal injury or property damage.

WARNING

NOTE: CATALOG DIMENSIONS

Every effort is made to keep all catalog dimensions and styles current in the catalog, however from time to time, it is necessary because of manufacturing changes to alter stock products dimensionally.

If any stock product dimension or style shown in this catalog is critical to your application please consult factory for certification.



USA

Corporate Offices Sales & Manufacturing

Arlington, TX
817-258-3000 (FAX 817-258-3333)

Regional Manufacturing Plants

Albemarle, NC
704-982-9555 (FAX 704-982-9599)
Atlanta, GA
404-292-8744 (FAX 404-292-7771)
Burleson, TX
817-295-7151 (FAX 817-447-3840)
Danielsville, PA
610-837-1841 (FAX 610-837-7337)
Ft. Worth, TX
817-258-3000 (FAX 817-258-3173)
Montpelier, OH
419-485-5515 (FAX 419-485-3565)
Sacramento, CA
916-441-7172 (FAX 916-441-4600)

Branch Manufacturing Plants

Boston, MA
508-634-3990 (FAX 508-634-3998)
Charlotte, NC
704-394-9111 (FAX 704-394-9122)
Chicago, IL
847-298-8844 (FAX 847-298-2967)
Denver, CO
303-371-8466 (FAX 303-371-7116)
Houston, TX
713-849-4330 (FAX 713-849-4807)
Kansas City, MO
816-231-5575 (FAX 816-231-1959)
Los Angeles, CA
323-728-8117 (FAX 323-722-7526)
Minneapolis, MN
952-829-0623 (FAX 952-944-9385)
Nashville, TN
615-871-4730 (FAX 615-871-4125)
Pittsburgh, PA
817-258-3000 (FAX 817-258-3333)
Portland, OR
503-223-7261 (FAX 503-221-0203)
Tampa, FL
813-623-1705 (FAX 813-626-8953)

Manufacturing Only

Abilene, TX • Clarksville, TX • Dallas, TX
Mansfield, TX • Paragould, AR

CANADA

Cambridge, Ontario
519-621-0546 (FAX 519-621-4413)
Edmonton, Alberta
780-450-0888 (FAX 780-465-0079)
Mississauga, Ontario
905-670-1991 (FAX 905-670-2110)

MEXICO

Guadalajara, JAL
+52 33-3283-1188 (Fax +52 33-3271-8450)
Monterrey, N.L.
+52 811 156 6830 (FAX +52 81-1156-6833)
Toluca, MEX
+52 722 276 0800 (Fax +52 722-276-0801)

BRAZIL

São Paulo, SP
+55 19 3877 9400 (Fax +55 19-3877-9429)

CHINA

Shanghai
+86-021-6708-4888 (FAX +86-021-6708-4889)
Changzhou • Fuzhou • Tianjin